

An algorithm with reduced number of multiplications for computing the 1-D integer transform of HEVC using recursive factorization and odd-part circulant transform

A. Tarpai
 <tarpai76 at gmail dot com>

Abstract – The HEVC Standard [3] defines an integer transform coding process together with a unified integer transform matrix to approximate the one-dimensional DCT for all transform sizes. This paper presents an algorithm that reduces the number of multiplications in the decoder for computing these matrix-vector products by finding symmetries in the integer DCT matrix and by transforming the odd DCT parts with permutation matrices to a circulant form, which gives possibilities for faster computation through recursive decomposition. The overall result in the case of the largest 32-point 1-D transform with this method is 120 multiplications (88% decrease) – without counting several constants, which can be implemented by shift. The algorithm is systematic and can be applied to any order- $2n$ real or integer transform.

Introduction

H.265/HEVC utilizes discrete cosine transform (DCT) coding for variable sizes of $N \times N$ image blocks ($N=2^n$, $2 \leq n \leq 5$). The two dimensional transform is computed as $2 \times N$ one dimensional transform first on columns then rows of the input block in the form of integer matrix-vector multiplication, results are shifted right with rounding after each 1-D transform.

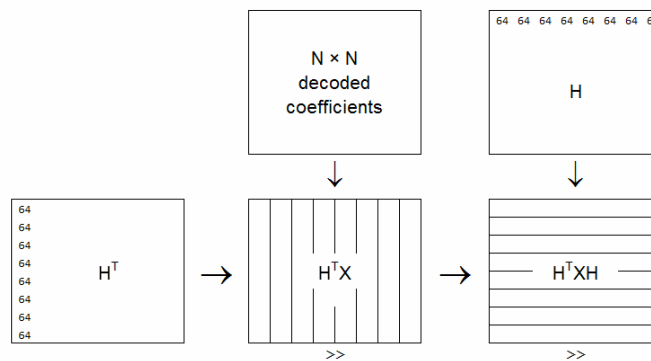

Principles of the 2-D inverse integer transform

One 32×32 integer matrix is defined by the Standard for the 1-D transform; lower order- N transforms use a subset of the same matrix values. The integer transform process ensures bit-exact results between encoders and decoders and is a good approximation of the real DCT transform.

The naïve matrix-vector product on the largest 32-point transform would require 1024 and for the whole 32×32 block the two dimensional transform would require 65536 multiplications. Finding fast algorithms for computing these high order integer transforms could greatly speed up the decoding

process. The main focus of this paper is the inverse transform for the HEVC decoder – but it is worth mentioning that the algorithm for the forward transform has exactly the same complexity.

In Part I the number of multiplications required to solve the matrix-vector product are recursively reduced based on symmetries of the integer matrix and has been derived solely by observing the matrix values. The explanation lies in the relationship with the real DCT matrix reflecting the same alternating even/odd symmetric structure. It leads to an algorithm similar to other recursive DCT kernel factorizations known from the literature, yet it is discussed in detail as it gives the basic structure for the final algorithm. With this method the 32-point transform can be computed with 340 multiplications (66% decrease).

Part II focuses on reducing the number of multiplications for computing the remaining odd DCT matrix-vector products. With a rather systematic approach I have found a class of permutation matrices, which transforms the odd DCT matrices (A) to a sort of circulant form (C) by the equation $C = PAP^{-1}$, where P is a signed permutation matrix. Then a procedure that recursively calculate the solution with 9, 27 and 81 parallel multiplications for the odd part of the 8×8 , 16×16 and 32×32 DCT matrix, respectively. Integrating these findings into the fully factorized algorithm of Part I the final algorithm further reduces the number of multiplications to 3, 12, 39 and 120 for the 4-, 8-, 16- and 32-point 1-D transform of HEVC.

In Part III code for the inverse transform (HEVC decoder) will be implemented in C for all transform sizes.

Part I. Recursive reduction of multiplications based on symmetries

Computing the 1-D inverse integer transform in the decoder is equivalent to the matrix-vector multiplication of $y_n = H_n x_n$, where H is the integer matrix defined by the Standard, x and y are column vectors with $n = 4, 8, 16$ or 32 elements. Lower transform sizes sub-sample H , denoted by shaded values:

0	1	2	3	4	5	6	7	8	9	10	11	12	13	14	15	16	17	18	19	20	21	22	23	24	25	26	27	28	29	30	31
64	90	90	90	89	88	87	85	83	82	80	78	75	73	70	67	64	61	57	54	50	46	43	38	36	31	25	22	18	13	9	4
64	90	87	82	75	67	57	46	36	22	9	-4	-18	-31	-43	-54	-64	-73	-80	-85	-89	-90	-90	-88	-83	-78	-70	-61	-50	-38	-25	-13
64	88	80	67	50	31	9	-13	-36	-54	-70	-82	-89	-90	-87	-78	-64	-46	-25	-4	18	38	57	73	83	90	90	85	75	61	43	22
64	85	70	46	18	-13	-43	-67	-83	-90	-87	-73	-50	-22	9	38	64	82	90	88	75	54	25	-4	-36	-61	-80	-90	-89	-78	-57	-31
64	82	57	22	-18	-54	-80	-90	-83	-61	-25	13	50	78	90	85	64	31	-9	-46	-75	-90	-87	-67	-36	4	43	73	89	88	70	38
64	78	43	-4	-50	-82	-90	-73	-36	13	57	85	89	67	25	-22	-64	-88	-87	-61	-18	31	70	90	83	54	9	-38	-75	-90	-80	-46
64	73	25	-31	-75	-90	-70	-22	36	78	90	67	18	-38	-80	-90	-64	-13	43	82	89	61	9	-46	-83	-88	-57	-4	50	85	87	54
64	67	9	-54	-89	-78	-25	38	83	85	43	-22	-75	-90	-57	4	64	90	70	13	-50	-88	-80	-31	-36	82	87	46	-18	-73	-90	-61
64	61	-9	-73	-89	-46	25	82	83	31	-43	-88	-75	-13	57	90	64	-4	-70	-90	-50	22	80	85	36	-38	-87	-78	-18	54	90	67
64	54	-25	-85	-75	-4	70	88	36	-46	-90	-61	18	82	80	13	-64	-90	-43	38	89	67	-9	-78	-83	-22	57	90	50	-31	-87	-73
64	46	-43	-90	-50	38	90	54	-36	-90	-57	31	89	61	-25	-88	-64	22	87	67	-18	-85	-70	13	83	73	-9	-82	-75	4	80	78
64	38	-57	-88	-18	73	80	-4	-83	-67	25	90	50	-46	-90	-31	64	85	9	-78	-75	13	87	61	-36	-90	-43	54	89	22	-70	-82
64	31	-70	-78	18	90	43	-61	-83	4	87	54	-50	-88	-9	82	64	-38	-90	-22	75	73	-25	-90	-36	67	80	-13	-89	-46	57	85
64	22	-80	-61	50	85	-9	-90	-36	73	70	-38	-89	-4	87	46	-64	-78	25	90	18	-82	-57	54	83	-13	-90	-31	75	67	-43	-88
64	13	-87	-38	75	61	-57	-78	36	88	-9	-90	-18	85	43	-73	-64	54	80	-31	-89	4	90	22	-83	-46	70	67	-50	-82	25	90
64	4	-90	-13	89	22	-87	-31	83	38	-80	-46	75	54	-70	-61	64	67	-57	-73	50	78	-43	-82	36	85	-25	-88	18	90	-9	-90
64	-4	-90	13	89	-22	-87	31	83	-38	-80	46	75	-54	-70	61	64	-67	-57	73	50	-78	-43	82	36	-85	-25	88	18	90	-9	90
64	-13	-87	38	75	-61	-57	78	36	-88	-9	90	-18	-85	43	73	-64	-54	80	31	-89	-4	90	-22	-83	46	70	-67	-50	82	25	-90
64	-22	-80	61	50	-85	-9	90	-36	-73	70	38	-89	4	87	-46	-64	78	25	-90	18	82	-57	-54	83	13	-90	31	75	-67	-43	88
64	-31	-70	78	18	-90	43	61	-83	-4	87	-54	-50	88	-9	-82	64	38	-90	22	75	-73	-25	90	-36	-67	80	13	-89	46	57	-85
64	-38	-57	88	-18	-73	80	4	-83	67	25	-90	50	46	-90	31	64	-85	9	78	-75	-13	87	-61	-36	90	-43	-54	89	-22	-70	82
64	-46	-43	90	-50	-38	90	-54	-36	90	-57	-31	89	-61	-25	88	-64	-22	87	-67	-18	85	-70	-13	83	-73	-9	82	-75	4	80	-78
64	-54	-25	85	-75	4	70	-88	36	46	-90	61	18	-82	80	-13	-64	90	-43	-38	89	-67	-9	78	-83	22	57	-90	50	31	-87	73
64	-61	-9	73	-89	46	25	-82	83	-31	-43	88	-75	13	57	-90	64	4	-70	90	-50	-22	80	-85	36	38	-87	78	-18	-54	90	-67
64	-67	9	54	-89	78	-25	-38	83	-85	43	22	-75	90	-57	-4	64	-90	70	-13	-50	88	-80	31	36	-82	87	-46	-18	73	-90	61
64	-73	25	31	-75	90	-70	22	36	-78	90	-67	18	38	-80	90	-64	13	43	-82	89	-61	9	46	-83	88	-57	4	50	-85	87	-54
64	-78	43	4	-50	82	-90	73	-36	-13	57	-85	89	-67	25	22	-64	88	-87	61	-18	-31	70	-90	83	-54	9	38	-75	90	80	46
64	-82	57	-22	-18	54	-80	90	-83	61	-25	-13	50	-78	90	-85	64	-31	-9	46	-75	90	-87	67	-36	-4	43	-73	89	-88	70	-38
64	-85	70	-46	18	13	-43	67	-83	90	-87	73	-50	22	9	-38	64	-82	90	-88	75	-54	25	4	-36	61	-80	90	-89	78	-57	31
64	-88	80	-67	50	-31	9	13	-36	54	-70	82	-89	90	-87	78	-64	46	-25	4	18	-38	57	-73	83	-90	90	-85	75	-61	43	-22
64	-90	87	-82	75	-67	57	-46	36	-22	9	4	-18	31	-43	54	-64	73	-80	85	-89	90	-90	88	-83	78	-70	61	-50	38	-25	13
64	-90	90	-90	89	-88	87	-85	83	-82	80	-78	75	-73	70	-67	64	-61	57	-54	50	-46	43	-38	36	-31	25	-22	18	-13	9	4

H_{32}

First let us examine H_8 , the 8x8 integer matrix used for the 8-point inverse transform then extend the procedure for higher order-N. Constants of $K_{i,j}$ in even columns appear symmetric, while in odd columns anti-symmetric:

	0	1	2	3	4	5	6	7
0	64	89	83	75	64	50	36	18
1	64	75	36	-18	-64	-89	-83	-50
2	64	50	-36	-89	-64	18	83	75
3	64	18	-83	-50	64	75	-36	-89
4	64	-18	-83	50	64	-75	-36	89
5	64	-50	-36	89	-64	-18	83	-75
6	64	-75	36	18	-64	89	-83	50
7	64	-89	83	-75	64	-50	36	-18

H_8

$$\begin{cases} K_{i,j} = K_{N-1-i,j}, & j \text{ even} \\ K_{i,j} = -K_{N-1-i,j}, & j \text{ odd} \end{cases}$$

$$N = 8, 0 \leq i \leq N/2 - 1, 0 \leq j \leq N - 1,$$

Rearranging columns to even- then odd order yields M_8 , revealing two sub-matrices of H_4 and A_4 appearing in reversed row order in the bottom half, denoted by r . H_4 is the 4x4 integer transform matrix itself, while A_4 is the odd part of the order-8 integer transform matrix:

	0	2	4	6	1	3	5	7
64	83	64	36	89	75	50	18	
64	36	-64	-83	75	-18	-89	-50	
64	-36	-64	83	50	-89	18	75	
64	-83	64	-36	18	-50	75	-89	
64	-83	64	-36	-18	50	-75	89	
64	-36	-64	83	-50	89	-18	-75	
64	36	-64	-83	-75	18	89	50	
64	83	64	36	-89	-75	-50	-18	

M_8

H_4	A_4
H_4^r	$-A_4^r$

h_0	a_0
h_1	a_1
h_2	a_2
h_3	a_3
h_3	$-a_3$
h_2	$-a_2$
h_1	$-a_1$
h_0	$-a_0$

Instead of solving H_8x with 64 multiplications, the same result can be achieved with 16+16=32 multiplications by solving the two sub-matrix-vector products of H_4x_{even} and A_4x_{odd} , followed by addition for the first half of y and subtraction (in reverse order) for the second half*. In matrix form:

$$y = H_8x = M_8 \begin{pmatrix} x_{even} \\ x_{odd} \end{pmatrix} = B_8 \begin{pmatrix} H_4 & \\ & A_4 \end{pmatrix} \begin{pmatrix} x_{even} \\ x_{odd} \end{pmatrix},$$

where B_8 is a symmetric matrix for addition and subtraction of the half-vector terms $h_i x_{even}$ and $a_i x_{odd}$ in proper order. B_8 can also be partitioned into 4 identity- and reverse identity sub-matrices:

$$B_8 = \begin{bmatrix} 1 & 0 & 0 & 0 & 1 & 0 & 0 & 0 \\ 0 & 1 & 0 & 0 & 0 & 1 & 0 & 0 \\ 0 & 0 & 1 & 0 & 0 & 0 & 1 & 0 \\ 0 & 0 & 0 & 1 & 0 & 0 & 0 & 1 \\ 0 & 0 & 0 & 1 & 0 & 0 & 0 & -1 \\ 0 & 0 & 1 & 0 & 0 & 0 & -1 & 0 \\ 0 & 1 & 0 & 0 & 0 & -1 & 0 & 0 \\ 1 & 0 & 0 & 0 & -1 & 0 & 0 & 0 \end{bmatrix} = \begin{bmatrix} I_4 & I_4 \\ I_4^r & -I_4^r \end{bmatrix}$$

Furthermore, H_4 above shows the same type of alternating even- and odd column symmetries and after similar column arrangement yields M_4 , with two sub-matrices of H_2 and A_2 :

* Reversing the order of the lower half can be either implemented into x -permutation or the order of subtractions in B .

	0	1	2	3		0	2	1	3		0	2	1	3
0	64	83	64	36		64	64	83	36		H ₂		A ₂	
1	64	36	-64	-83		64	-64	36	-83					
2	64	-36	-64	83		64	-64	-36	83				-A ₂ ^r	
3	64	-83	64	-36		64	64	-83	-36					
	H ₄					M ₄								

Suggesting H_4x (and the 4-point transform) can be solved with 4+4=8 multiplications instead of 16 according to

$$y = H_4x = M_4 \begin{pmatrix} x_{even} \\ x_{odd} \end{pmatrix} = B_4 \begin{pmatrix} H_2 & \\ & A_2 \end{pmatrix} \begin{pmatrix} x_{even} \\ x_{odd} \end{pmatrix} = \begin{pmatrix} I_2 & I_2 \\ I_2^r & -I_2^r \end{pmatrix} \begin{pmatrix} H_2 & \\ & A_2 \end{pmatrix} \begin{pmatrix} x_{even} \\ x_{odd} \end{pmatrix}$$

Furthermore, the upper 2x2 block of M_4 is in the same symmetry structure, the 2-point transform matrix, and thus can be computed with 2 multiplications:

$$y = \begin{pmatrix} 64 & 64 \\ 64 & -64 \end{pmatrix} \begin{pmatrix} x_0 \\ x_1 \end{pmatrix} = B_2 \begin{pmatrix} 64 & \\ & 64 \end{pmatrix} \begin{pmatrix} x_0 \\ x_1 \end{pmatrix} = \begin{pmatrix} 1 & 1 \\ 1 & -1 \end{pmatrix} \begin{pmatrix} 64 & \\ & 64 \end{pmatrix} \begin{pmatrix} x_0 \\ x_1 \end{pmatrix}$$

As a result, multiplications were halved, and then recursively halved in each even half until scalar operations have been reached. H_8 has been factorized into a block diagonalized (A) and an additive matrix B, where $B=B_8B_4B_2^*$:

$$y = H_8x = BAPx = B \begin{pmatrix} A_1 & & & \\ & A_1 & & \\ & & A_2 & \\ & & & A_1 \end{pmatrix} Px = \begin{pmatrix} 1 & 1 & 1 & 1 \\ 1 & -1 & 1 & 1 \\ 1 & -1 & -1 & 1 \\ 1 & 1 & -1 & 1 \\ 1 & 1 & -1 & -1 \\ 1 & -1 & -1 & -1 \\ 1 & -1 & 1 & -1 \\ 1 & 1 & 1 & -1 \end{pmatrix} \begin{pmatrix} 64 & & & \\ & 64 & & \\ & & 83 & 36 \\ & & 36 & -83 \\ & & & & 89 & 75 & 50 & 18 \\ & & & & 75 & -18 & -89 & -50 \\ & & & & 50 & -89 & 18 & 75 \\ & & & & 18 & -50 & 75 & -89 \end{pmatrix} \begin{pmatrix} x_0 \\ x_4 \\ x_2 \\ x_6 \\ x_1 \\ x_3 \\ x_5 \\ x_7 \end{pmatrix}$$

To verify the above equation through an example, below is the 8-point integer transform matrix with an arbitrary column vector x . The naïve matrix-vector multiplication of $y=H_8x$ uses 64 multiplications:

x	H ₈	y
165	64 89 83 75 64 50 36 18	7122
18	64 75 36 -18 -64 -89 -83 -50	23489
41	64 50 -36 -89 -64 18 83 75	10104
-25	64 18 -83 -50 64 75 -36 -89	8691
-75	64 -18 -83 50 64 -75 -36 89	4087
37	64 -50 -36 89 -64 -18 83 -75	-928
-112	64 -75 36 18 -64 89 -83 50	28775
23	64 -89 83 -75 64 -50 36 -18	3140

Entering matrices of A_n and B_n into a spreadsheet reveals the algorithm and the basis for code generation. The input vector is permuted to a recursive-even and odd order. First computing the 2-point transform with x_0 and x_4 : multiply by 64 (or left-shift) and add/sub results by B_2 . With x_2, x_6 perform matrix multiplication by A_2 . Add/sub results by B_4 . From x_{odd} perform matrix multiplication by A_4 . Add/sub results by B_8 . Data flows from left to right:

* More precisely B_4 and B_2 are extended to 8x8 by diagonal one-s before the matrix multiplication; while P is a permutation matrix.

	x		B₂		B₄		B₈		y															
x0	165	<table border="1"><tr><td>64</td></tr></table>	64	10560	<table border="1"><tr><td>1</td><td>1</td></tr></table>	1	1	5760	<table border="1"><tr><td>1</td><td>0</td><td>1</td><td>0</td></tr></table>	1	0	1	0	5131	<table border="1"><tr><td>1</td><td>0</td><td>0</td><td>0</td><td>1</td><td>0</td><td>0</td><td>0</td></tr></table>	1	0	0	0	1	0	0	0	7122
64																								
1	1																							
1	0	1	0																					
1	0	0	0	1	0	0	0																	
x4	-75	<table border="1"><tr><td>64</td></tr></table>	64	-4800	<table border="1"><tr><td>1</td><td>-1</td></tr></table>	1	-1	15360	<table border="1"><tr><td>0</td><td>1</td><td>0</td><td>1</td></tr></table>	0	1	0	1	26132	<table border="1"><tr><td>0</td><td>1</td><td>0</td><td>0</td><td>0</td><td>1</td><td>0</td><td>0</td></tr></table>	0	1	0	0	0	1	0	0	23489
64																								
1	-1																							
0	1	0	1																					
0	1	0	0	0	1	0	0																	
x2	41			<table border="1"><tr><td>83</td><td>36</td></tr></table>	83	36	-629	<table border="1"><tr><td>0</td><td>1</td><td>0</td><td>-1</td></tr></table>	0	1	0	-1	4588	<table border="1"><tr><td>0</td><td>0</td><td>1</td><td>0</td><td>0</td><td>0</td><td>1</td><td>0</td></tr></table>	0	0	1	0	0	0	1	0	10104	
83	36																							
0	1	0	-1																					
0	0	1	0	0	0	1	0																	
x6	-112			<table border="1"><tr><td>36</td><td>-83</td></tr></table>	36	-83	10772	<table border="1"><tr><td>1</td><td>0</td><td>-1</td><td>0</td></tr></table>	1	0	-1	0	6389	<table border="1"><tr><td>0</td><td>0</td><td>0</td><td>1</td><td>0</td><td>0</td><td>0</td><td>1</td></tr></table>	0	0	0	1	0	0	0	1	8691	
36	-83																							
1	0	-1	0																					
0	0	0	1	0	0	0	1																	
x1	18					<table border="1"><tr><td>89</td><td>75</td><td>50</td><td>18</td></tr></table>	89	75	50	18	1991	<table border="1"><tr><td>0</td><td>0</td><td>0</td><td>1</td><td>0</td><td>0</td><td>0</td><td>-1</td></tr></table>	0	0	0	1	0	0	0	-1	4087			
89	75	50	18																					
0	0	0	1	0	0	0	-1																	
x3	-25					<table border="1"><tr><td>75</td><td>-18</td><td>-89</td><td>-50</td></tr></table>	75	-18	-89	-50	-2643	<table border="1"><tr><td>0</td><td>0</td><td>1</td><td>0</td><td>0</td><td>0</td><td>-1</td><td>0</td></tr></table>	0	0	1	0	0	0	-1	0	-928			
75	-18	-89	-50																					
0	0	1	0	0	0	-1	0																	
x5	37					<table border="1"><tr><td>50</td><td>-89</td><td>18</td><td>75</td></tr></table>	50	-89	18	75	5516	<table border="1"><tr><td>0</td><td>1</td><td>0</td><td>0</td><td>0</td><td>-1</td><td>0</td><td>0</td></tr></table>	0	1	0	0	0	-1	0	0	28775			
50	-89	18	75																					
0	1	0	0	0	-1	0	0																	
x7	23					<table border="1"><tr><td>18</td><td>-50</td><td>75</td><td>-89</td></tr></table>	18	-50	75	-89	2302	<table border="1"><tr><td>1</td><td>0</td><td>0</td><td>0</td><td>-1</td><td>0</td><td>0</td><td>0</td></tr></table>	1	0	0	0	-1	0	0	0	3140			
18	-50	75	-89																					
1	0	0	0	-1	0	0	0																	
			A₂		A₄																			

This algorithm uses 22 – or 20 not counting by 64 – multiplications with equal result computed as a series of matrix-vector products of $B_n x$ and $A_n x$, where only $A_n x$ requires multiplications (in Part II we will improve on computing these). The input vector is permuted, B_n are symmetric additive- and A_n are the integer odd part DCT matrices.

By observing H_{32} , the whole matrix appears in a similar structure showing alternating even/odd column symmetries. Rearranging columns* of H_{32} starting from the lowest transform size reveals the four order-N matrices of M_4 , M_8 , M_{16} and M_{32} used for different transform sizes:

0	16	8	24	4	12	20	28	2	6	10	14	18	22	26	30	1	3	5	7	9	11	13	15	17	19	21	23	25	27	29	31		
64	64	83	36	89	75	50	18	90	87	80	70	57	43	25	9	90	90	88	85	82	78	73	67	61	54	46	38	31	22	13	4		
64	-64	-36	-83	75	-18	-89	-50	87	57	9	-43	-80	-90	-70	-25	90	82	67	46	22	-4	-31	-54	-73	-85	-90	-88	-78	-61	-38	-13		
64	-64	-36	83	50	-89	-18	75	80	9	-70	-87	-25	67	90	43	88	67	31	-13	-54	-82	-90	-78	-46	-4	38	73	90	85	61	22		
64	64	-83	-36	18	-50	75	-89	70	-43	-87	9	90	25	-80	-57	85	46	-13	-67	-90	-73	-22	38	82	88	54	-4	-61	-90	-78	-31		
64	64	-83	-36	-18	50	-75	89	57	-80	-25	90	-9	-87	43	70	82	22	-54	-90	-61	13	78	85	31	-46	-90	-67	4	73	88	38		
64	-64	36	-83	-75	18	89	50	25	-70	90	-80	43	9	-57	87	73	-31	-90	-22	78	67	-38	-90	-13	82	61	-46	-88	-4	85	54		
64	64	83	36	-89	-75	-50	-18	9	-25	43	-57	70	-80	87	-90	67	-54	-78	38	85	-22	-90	4	90	13	-88	-31	82	46	-73	-61		
64	64	83	36	-89	-75	-50	-18	-9	25	-43	57	-70	80	-87	90	61	-73	-46	82	31	-88	-13	90	-4	-90	22	85	-38	-78	54	67		
64	-64	36	-83	-75	18	89	50	-25	70	-90	80	-43	-9	57	-87	54	-85	-4	88	-46	-61	82	13	-90	38	67	-78	-22	90	-31	-73		
64	-64	-36	83	-50	89	-18	-75	-43	90	-57	-25	87	-70	-9	80	46	-90	38	54	-90	31	61	-88	22	67	-85	13	73	-82	4	78		
64	64	-83	-36	-18	50	-75	89	-57	80	25	-90	9	87	-43	70	38	-88	73	-4	-67	90	-46	-31	85	-78	13	61	-90	54	22	-82		
64	64	-83	-36	-18	50	-75	89	-70	43	87	-9	-90	-25	80	57	31	-78	90	-61	4	54	-88	82	-38	-22	73	-90	67	-13	-46	85		
64	-64	36	-83	-75	18	89	50	-9	70	87	25	-57	-90	-43	22	-61	85	-90	73	-38	-4	46	-78	90	-82	54	-13	-31	67	-88			
64	-64	36	-83	-75	-18	-89	-50	-87	-57	-9	43	80	90	70	25	13	-38	61	-78	88	-90	85	-73	54	-31	4	22	-46	67	-82	90		
64	64	83	36	89	75	50	18	-90	-87	-80	-70	-57	-43	-25	-9	4	-13	22	-31	38	-46	54	-61	67	-73	78	-82	85	-88	90	-90		
64	64	83	36	89	75	50	18	-90	-87	-80	-70	-57	-43	-25	-9	-4	13	-22	31	-38	46	-54	61	-67	73	-78	82	-85	88	-90	90		
64	-64	36	-83	-75	-18	-89	-50	-87	-57	-9	43	80	90	70	25	-13	38	-61	78	-88	90	-85	73	-54	31	-4	-22	46	-67	82	-90		
64	-64	-36	83	-50	89	-18	75	-80	-9	70	87	25	-57	-90	-43	-22	61	-85	90	-73	38	4	46	78	-90	82	-54	13	31	-67	88		
64	64	-83	-36	18	-50	75	-89	-70	43	87	-9	-90	-25	80	57	-31	78	90	61	-4	54	88	82	-38	-22	73	-90	67	-13	-46	85		
64	64	-83	-36	-18	50	-75	89	-57	80	25	-90	9	87	-43	70	-38	88	-73	4	67	-90	46	31	-85	78	-13	-61	90	-54	-22	82		
64	-64	36	-83	-75	18	89	50	-18	-75	-43	90	-57	-25	87	-70	-9	80	-46	90	-38	-54	90	-31	-61	88	-22	-67	85	-13	-73	82	-4	-78
64	-64	36	-83	-75	18	89	50	-25	70	-90	80	-43	-9	57	-87	-54	85	4	-88	46	61	-82	-13	90	-38	-67	78	22	-90	31	73		
64	64	83	36	-89	-75	-50	-18	-9	25	-43	57	-70	80	-87	90	-61	73	46	-82	-31	88	13	-90	4	90	-22	-85	38	78	-54	-67		
64	64	83	36	-89	-75	-50	-18	-9	25	-43	57	-70	-80	87	-90	-67	54	78	-38	-85	22	90	-4	-90	-13	88	31	-82	-46	73	61		
64	-64	36	-83	-75	18	89	50	25	-70	90	-80	43	9	-57	87	-73	31	90	22	-78	-67	38	90	13	-82	-61	46	88	4	-85	-54		
64	-64	-36	83	-50	89	-18	-75	-43	-90	57	25	-87	70	9	-80	-78	4	82	73	-13	-85	-67	22	88	61	-31	-90	-54	38	90	46		
64	64	-83	-36	-18	50	-75	89	57	-80	-25	90	-9	-87	43	70	-82	-22	54	90	61	-13	-78	85	-31	46	90	67	-4	-73	-88	-38		
64	64	-83	-36	-18	50	-75	89	-70	43	-87	9	90	25	-80	-57	-85	-46	13	67	90	73	22	-38	-82	-88	-54	4	61	90	78	31		
64	-64	36	-83	-75	-18	-89	-50	87	57	9	-43	-80	-90	-70	-25	90	43	-88	-67	-31	13	54	82	90	78	46	4	-38	-73	-90	-85	-61	-22
64	-64	36	-83	-75	-18	-89	-50	87	57	9	-43	-80	-90	-70	-25	-90	-82	-67	-46	-22	4	31	54	73	85	90	88	78	61	38	13		
64	64	83	36	89	75	50	18	90	87	80	70	57	43	25	9	-90	-90	-88	-85	-82	-78	-73	-67	-61	-54	-46	-38	-31	-22	-13	-4		

$$M_4 = \begin{pmatrix} H_2 & A_2 \\ H_2^r & -A_2^r \end{pmatrix}$$

$$M_8 = \begin{pmatrix} M_4 & A_4 \\ M_4^r & -A_4^r \end{pmatrix}$$

$$M_{16} = \begin{pmatrix} M_8 & A_8 \\ M_8^r & -A_8^r \end{pmatrix}$$

$$M_{32} = \begin{pmatrix} M_{16} & A_{16} \\ M_{16}^r & -A_{16}^r \end{pmatrix}$$

This already suggests some recursive computation as each M_n contains lower transform matrices. For higher order transforms, the 8x8 transform matrix is the upper left 8x8 block of the 16x16 transform matrix, and the 16x16 transform matrix is the upper left 16x16 block of the 32x32 transform matrix.

To verify whether this assumption holds the data flow is extended below with the order-16 and order-32 odd DCT matrices (A_8 and A_{16}) and the corresponding B_{16} and B_{32} additive matrices. The data flow is based on the full matrix factorization of H_{32} as:

* Rearranging columns and the corresponding permutation of the input column vector x causes no additional computational complexity when computing the matrix-vector product.

only the solution was published, but [1] used a permutation matrix to transform the odd DCT matrix A to some circular form of C according to $C=PAP^{-1}$, where P is a signed permutation matrix. An attractive feature of circulant matrices is solving the matrix-vector product with fewer multiplications, i.e. all multiplications by A narrows down to fewer multiplications used by C .

So the question and the quest of this paper is whether such P_n signed permutation matrix exists for all of the order- 2^n DCT odd matrix parts, how can be found from $2^n n!$ possibilities, what is the algorithm for the data flow and how to generate the C code for the HEVC decoder.

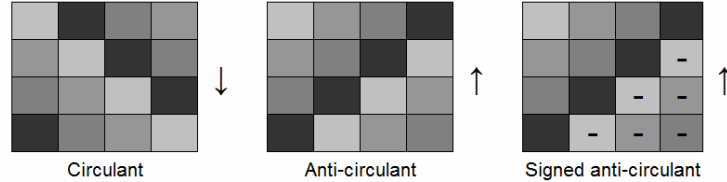

An $n \times n$ circulant matrix can be constructed by cycling a column vector *down*, resulting in a square matrix with n elements arranged so that the matrix has same values along diagonals. Let us call matrices with same values along anti-diagonals as *anti-circulant*, derived by cycling the first column vector *up*. According to the results presented in this paper the odd DCT matrix part can be transformed to a so called *signed-anti-circulant* format by applying $C=PAP^{-1}$, where P are various signed permutation matrices. The structure of signed-anti-circulant is similar to anti-circulant, same values along anti-diagonals, except from the rotated element is negated.

Example

As an example, let us solve the matrix multiplication for $y=Ax$ for A_4 , the 4×4 odd part of the order-8 integer DCT matrix. This would require 16 multiplications:

$$\begin{array}{c} \mathbf{A} \\ \hline \begin{array}{cccc} 89 & 75 & 50 & 18 \\ 75 & -18 & -89 & -50 \\ 50 & -89 & 18 & 75 \\ 18 & -50 & 75 & -89 \end{array} \end{array} \begin{array}{c} \mathbf{x} \\ \hline \begin{array}{c} x_0 \\ x_1 \\ x_2 \\ x_3 \end{array} \end{array} = \begin{array}{c} \mathbf{y} \\ \hline \begin{array}{c} y_0 \\ y_1 \\ y_2 \\ y_3 \end{array} \end{array}$$

Let $C=PAP^{-1}$, where P is a permutation matrix:

$$\begin{array}{c} \mathbf{P} \\ \hline \begin{array}{cccc} 1 & 0 & 0 & 0 \\ 0 & 0 & 1 & 0 \\ 0 & 0 & 0 & 1 \\ 0 & 1 & 0 & 0 \end{array} \end{array} \begin{array}{c} \mathbf{A} \\ \hline \begin{array}{cccc} 89 & 75 & 50 & 18 \\ 75 & -18 & -89 & -50 \\ 50 & -89 & 18 & 75 \\ 18 & -50 & 75 & -89 \end{array} \end{array} \begin{array}{c} \mathbf{P}^{-1} \\ \hline \begin{array}{cccc} 1 & 0 & 0 & 0 \\ 0 & 0 & 0 & 1 \\ 0 & 1 & 0 & 0 \\ 0 & 0 & 1 & 0 \end{array} \end{array} = \begin{array}{c} \mathbf{C} \\ \hline \begin{array}{cc|cc} 89 & 50 & 18 & 75 \\ 50 & 18 & 75 & -89 \\ \hline 18 & 75 & -89 & -50 \\ 75 & -89 & -50 & -18 \end{array} \end{array}$$

C is not strictly a circulant matrix by definition, but has a circular structure: same values along anti-diagonals (i.e. *signed anti-circulant*). From the above $A= P^{-1}CP$ using that permutation matrices are orthogonal and $P^{-1}P=I$.

Substituting into the original equation we get $y = Ax = P^{-1}CPx$ or $y = P^{-1} (C (Px))$ based on matrix product associativity. Because of multiplying by P or P^{-1} is only row- or column permutation with sign-change, this essentially means that multiplications will only appear during computing the $(C)(permuted-x)$ product:

$$\begin{array}{|c|c|c|c|} \hline \mathbf{C} & & & \\ \hline 89 & 50 & 18 & 75 \\ \hline 50 & 18 & 75 & -89 \\ \hline 18 & 75 & -89 & -50 \\ \hline 75 & -89 & -50 & -18 \\ \hline \end{array} \quad \begin{array}{|c|} \hline \mathbf{Px} \\ \hline x_0 \\ \hline x_2 \\ \hline x_3 \\ \hline x_1 \\ \hline \end{array} = \begin{array}{|c|} \hline \mathbf{CPx} \\ \hline y_0 \\ \hline y_2 \\ \hline y_3 \\ \hline y_1 \\ \hline \end{array}$$

Now $C(Px)$ can be solved with fewer multiplications than the naïve 16. Each of the 2×2 blocks has two equal anti-diagonal values $\begin{bmatrix} u & d \\ d & v \end{bmatrix}$. Furthermore, partitioning C into 2×2 blocks we get

$$C = \begin{bmatrix} U & D \\ D & V \end{bmatrix}, \text{ where the two } D \text{ sub-matrices are again equal. Both the scalar and the matrix form of such structures can be solved with 3 multiplications instead of 4. For the scalar case of } \begin{bmatrix} y_0 \\ y_1 \end{bmatrix} = \begin{bmatrix} u & d \\ d & v \end{bmatrix} \begin{bmatrix} x_0 \\ x_1 \end{bmatrix} \text{ we get:}$$

$$\begin{aligned} t &= d(x_0 + x_1) \\ y_0 &= t + (u - d)x_0 \\ y_1 &= t + (v - d)x_1 \end{aligned}$$

The matrix form is $\begin{bmatrix} Y_0 \\ Y_1 \end{bmatrix} = \begin{bmatrix} U & D \\ D & V \end{bmatrix} \begin{bmatrix} X_0 \\ X_1 \end{bmatrix}$, where X, Y are the upper and the lower half of the column vectors. Then again

$$\begin{aligned} T &= D(X_0 + X_1) = \begin{bmatrix} 18 & 75 \\ 75 & -89 \end{bmatrix} \begin{bmatrix} x_0 + x_2 \\ x_1 + x_3 \end{bmatrix} = \begin{bmatrix} t_0 \\ t_1 \end{bmatrix} \\ Y_0 &= T + (U - D)X_0 = \begin{bmatrix} t_0 \\ t_1 \end{bmatrix} + \begin{bmatrix} 71 & -25 \\ -25 & 107 \end{bmatrix} \begin{bmatrix} x_0 \\ x_1 \end{bmatrix} = \begin{bmatrix} y_0 \\ y_1 \end{bmatrix} \\ Y_1 &= T + (V - D)X_1 = \begin{bmatrix} t_0 \\ t_1 \end{bmatrix} + \begin{bmatrix} -107 & -125 \\ -125 & 71 \end{bmatrix} \begin{bmatrix} x_2 \\ x_3 \end{bmatrix} = \begin{bmatrix} y_2 \\ y_3 \end{bmatrix} \end{aligned}$$

These 3 matrix-vector products are the scalar case above, thus $C(Px)$ can be solved using $3 \times 3 = 9$ multiplications. If P_8 and P_{16} exist as well, we predict solving A_8x and $A_{16}x$ with 27 and 81 multiplications instead of the naïve 64 and 256 – respectively – for the odd DCT matrix parts of HEVC.

Finding a permutation matrix

The P permutation matrix in the Example above is a solution for A_4 , that $C=PAP^{-1}$ has a circulant anti-diagonal structure. For higher order A_n finding P_n is not trivial. There are $n!$ possible permutation matrices of size $n \times n$. For signed permutation matrices each of these has 2^n possible variations with variable ± 1 elements, reaching $2^n n!$ to rather high numbers for $n=8$ and $n=16$. The task is to find a subset of these, which results in $C=PAP^{-1}$ in the desired structure.

Material and method

Without solid combinatory, matrix- and group theory, I used another method to find the right permutation matrix for each A_n of the integer DCT matrix. That is a spreadsheet and systematic approach, trial and error. First entering the steps of the equation $C=PAP^T$ into a spreadsheet starting

with an all-zero P matrix*. The PA product permutes rows of A , while AP^T permutes columns. Starting with $P_{1,1} = 1$, then continue with entering ± 1 values manually into P row-by-row observing the result in C , making sure anti-diagonals get the same value. The C matrix is colored by positive/negative to easily observe values along anti-diagonals. An example of the process for A_8 :

A	<table border="1"><tr><td>90</td><td>87</td><td>80</td><td>70</td><td>57</td><td>43</td><td>25</td><td>9</td></tr><tr><td>87</td><td>57</td><td>9</td><td>-43</td><td>-80</td><td>-90</td><td>-70</td><td>-25</td></tr><tr><td>80</td><td>9</td><td>-70</td><td>-87</td><td>-25</td><td>57</td><td>90</td><td>43</td></tr><tr><td>70</td><td>-43</td><td>-87</td><td>9</td><td>90</td><td>25</td><td>-80</td><td>-57</td></tr><tr><td>57</td><td>-80</td><td>-25</td><td>90</td><td>-9</td><td>-87</td><td>43</td><td>70</td></tr><tr><td>43</td><td>-90</td><td>57</td><td>25</td><td>-87</td><td>70</td><td>9</td><td>-80</td></tr><tr><td>25</td><td>-70</td><td>90</td><td>-80</td><td>43</td><td>9</td><td>-57</td><td>87</td></tr><tr><td>9</td><td>-25</td><td>43</td><td>-57</td><td>70</td><td>-80</td><td>87</td><td>-90</td></tr></table>	90	87	80	70	57	43	25	9	87	57	9	-43	-80	-90	-70	-25	80	9	-70	-87	-25	57	90	43	70	-43	-87	9	90	25	-80	-57	57	-80	-25	90	-9	-87	43	70	43	-90	57	25	-87	70	9	-80	25	-70	90	-80	43	9	-57	87	9	-25	43	-57	70	-80	87	-90	<table border="1"><tr><td>90</td><td>87</td><td>80</td><td>70</td><td>57</td><td>43</td><td>25</td><td>9</td></tr><tr><td>87</td><td>57</td><td>9</td><td>-43</td><td>-80</td><td>-90</td><td>-70</td><td>-25</td></tr><tr><td>80</td><td>9</td><td>-70</td><td>-87</td><td>-25</td><td>57</td><td>90</td><td>43</td></tr><tr><td>70</td><td>-43</td><td>-87</td><td>9</td><td>90</td><td>25</td><td>-80</td><td>-57</td></tr><tr><td>57</td><td>-80</td><td>-25</td><td>90</td><td>-9</td><td>-87</td><td>43</td><td>70</td></tr><tr><td>43</td><td>-90</td><td>57</td><td>25</td><td>-87</td><td>70</td><td>9</td><td>-80</td></tr><tr><td>25</td><td>-70</td><td>90</td><td>-80</td><td>43</td><td>9</td><td>-57</td><td>87</td></tr><tr><td>9</td><td>-25</td><td>43</td><td>-57</td><td>70</td><td>-80</td><td>87</td><td>-90</td></tr></table>	90	87	80	70	57	43	25	9	87	57	9	-43	-80	-90	-70	-25	80	9	-70	-87	-25	57	90	43	70	-43	-87	9	90	25	-80	-57	57	-80	-25	90	-9	-87	43	70	43	-90	57	25	-87	70	9	-80	25	-70	90	-80	43	9	-57	87	9	-25	43	-57	70	-80	87	-90	<table border="1"><tr><td>90</td><td>87</td><td>80</td><td>70</td><td>57</td><td>43</td><td>25</td><td>9</td></tr><tr><td>87</td><td>57</td><td>9</td><td>-43</td><td>-80</td><td>-90</td><td>-70</td><td>-25</td></tr><tr><td>80</td><td>9</td><td>-70</td><td>-87</td><td>-25</td><td>57</td><td>90</td><td>43</td></tr><tr><td>70</td><td>-43</td><td>-87</td><td>9</td><td>90</td><td>25</td><td>-80</td><td>-57</td></tr><tr><td>57</td><td>-80</td><td>-25</td><td>90</td><td>-9</td><td>-87</td><td>43</td><td>70</td></tr><tr><td>43</td><td>-90</td><td>57</td><td>25</td><td>-87</td><td>70</td><td>9</td><td>-80</td></tr><tr><td>25</td><td>-70</td><td>90</td><td>-80</td><td>43</td><td>9</td><td>-57</td><td>87</td></tr><tr><td>9</td><td>-25</td><td>43</td><td>-57</td><td>70</td><td>-80</td><td>87</td><td>-90</td></tr></table>	90	87	80	70	57	43	25	9	87	57	9	-43	-80	-90	-70	-25	80	9	-70	-87	-25	57	90	43	70	-43	-87	9	90	25	-80	-57	57	-80	-25	90	-9	-87	43	70	43	-90	57	25	-87	70	9	-80	25	-70	90	-80	43	9	-57	87	9	-25	43	-57	70	-80	87	-90	<table border="1"><tr><td>90</td><td>87</td><td>80</td><td>70</td><td>57</td><td>43</td><td>25</td><td>9</td></tr><tr><td>87</td><td>57</td><td>9</td><td>-43</td><td>-80</td><td>-90</td><td>-70</td><td>-25</td></tr><tr><td>80</td><td>9</td><td>-70</td><td>-87</td><td>-25</td><td>57</td><td>90</td><td>43</td></tr><tr><td>70</td><td>-43</td><td>-87</td><td>9</td><td>90</td><td>25</td><td>-80</td><td>-57</td></tr><tr><td>57</td><td>-80</td><td>-25</td><td>90</td><td>-9</td><td>-87</td><td>43</td><td>70</td></tr><tr><td>43</td><td>-90</td><td>57</td><td>25</td><td>-87</td><td>70</td><td>9</td><td>-80</td></tr><tr><td>25</td><td>-70</td><td>90</td><td>-80</td><td>43</td><td>9</td><td>-57</td><td>87</td></tr><tr><td>9</td><td>-25</td><td>43</td><td>-57</td><td>70</td><td>-80</td><td>87</td><td>-90</td></tr></table>	90	87	80	70	57	43	25	9	87	57	9	-43	-80	-90	-70	-25	80	9	-70	-87	-25	57	90	43	70	-43	-87	9	90	25	-80	-57	57	-80	-25	90	-9	-87	43	70	43	-90	57	25	-87	70	9	-80	25	-70	90	-80	43	9	-57	87	9	-25	43	-57	70	-80	87	-90	A	<table border="1"><tr><td>90</td><td>87</td><td>80</td><td>70</td><td>57</td><td>43</td><td>25</td><td>9</td></tr><tr><td>87</td><td>57</td><td>9</td><td>-43</td><td>-80</td><td>-90</td><td>-70</td><td>-25</td></tr><tr><td>80</td><td>9</td><td>-70</td><td>-87</td><td>-25</td><td>57</td><td>90</td><td>43</td></tr><tr><td>70</td><td>-43</td><td>-87</td><td>9</td><td>90</td><td>25</td><td>-80</td><td>-57</td></tr><tr><td>57</td><td>-80</td><td>-25</td><td>90</td><td>-9</td><td>-87</td><td>43</td><td>70</td></tr><tr><td>43</td><td>-90</td><td>57</td><td>25</td><td>-87</td><td>70</td><td>9</td><td>-80</td></tr><tr><td>25</td><td>-70</td><td>90</td><td>-80</td><td>43</td><td>9</td><td>-57</td><td>87</td></tr><tr><td>9</td><td>-25</td><td>43</td><td>-57</td><td>70</td><td>-80</td><td>87</td><td>-90</td></tr></table>	90	87	80	70	57	43	25	9	87	57	9	-43	-80	-90	-70	-25	80	9	-70	-87	-25	57	90	43	70	-43	-87	9	90	25	-80	-57	57	-80	-25	90	-9	-87	43	70	43	-90	57	25	-87	70	9	-80	25	-70	90	-80	43	9	-57	87	9	-25	43	-57	70	-80	87	-90
90	87	80	70	57	43	25	9																																																																																																																																																																																																																																																																																																																															
87	57	9	-43	-80	-90	-70	-25																																																																																																																																																																																																																																																																																																																															
80	9	-70	-87	-25	57	90	43																																																																																																																																																																																																																																																																																																																															
70	-43	-87	9	90	25	-80	-57																																																																																																																																																																																																																																																																																																																															
57	-80	-25	90	-9	-87	43	70																																																																																																																																																																																																																																																																																																																															
43	-90	57	25	-87	70	9	-80																																																																																																																																																																																																																																																																																																																															
25	-70	90	-80	43	9	-57	87																																																																																																																																																																																																																																																																																																																															
9	-25	43	-57	70	-80	87	-90																																																																																																																																																																																																																																																																																																																															
90	87	80	70	57	43	25	9																																																																																																																																																																																																																																																																																																																															
87	57	9	-43	-80	-90	-70	-25																																																																																																																																																																																																																																																																																																																															
80	9	-70	-87	-25	57	90	43																																																																																																																																																																																																																																																																																																																															
70	-43	-87	9	90	25	-80	-57																																																																																																																																																																																																																																																																																																																															
57	-80	-25	90	-9	-87	43	70																																																																																																																																																																																																																																																																																																																															
43	-90	57	25	-87	70	9	-80																																																																																																																																																																																																																																																																																																																															
25	-70	90	-80	43	9	-57	87																																																																																																																																																																																																																																																																																																																															
9	-25	43	-57	70	-80	87	-90																																																																																																																																																																																																																																																																																																																															
90	87	80	70	57	43	25	9																																																																																																																																																																																																																																																																																																																															
87	57	9	-43	-80	-90	-70	-25																																																																																																																																																																																																																																																																																																																															
80	9	-70	-87	-25	57	90	43																																																																																																																																																																																																																																																																																																																															
70	-43	-87	9	90	25	-80	-57																																																																																																																																																																																																																																																																																																																															
57	-80	-25	90	-9	-87	43	70																																																																																																																																																																																																																																																																																																																															
43	-90	57	25	-87	70	9	-80																																																																																																																																																																																																																																																																																																																															
25	-70	90	-80	43	9	-57	87																																																																																																																																																																																																																																																																																																																															
9	-25	43	-57	70	-80	87	-90																																																																																																																																																																																																																																																																																																																															
90	87	80	70	57	43	25	9																																																																																																																																																																																																																																																																																																																															
87	57	9	-43	-80	-90	-70	-25																																																																																																																																																																																																																																																																																																																															
80	9	-70	-87	-25	57	90	43																																																																																																																																																																																																																																																																																																																															
70	-43	-87	9	90	25	-80	-57																																																																																																																																																																																																																																																																																																																															
57	-80	-25	90	-9	-87	43	70																																																																																																																																																																																																																																																																																																																															
43	-90	57	25	-87	70	9	-80																																																																																																																																																																																																																																																																																																																															
25	-70	90	-80	43	9	-57	87																																																																																																																																																																																																																																																																																																																															
9	-25	43	-57	70	-80	87	-90																																																																																																																																																																																																																																																																																																																															
90	87	80	70	57	43	25	9																																																																																																																																																																																																																																																																																																																															
87	57	9	-43	-80	-90	-70	-25																																																																																																																																																																																																																																																																																																																															
80	9	-70	-87	-25	57	90	43																																																																																																																																																																																																																																																																																																																															
70	-43	-87	9	90	25	-80	-57																																																																																																																																																																																																																																																																																																																															
57	-80	-25	90	-9	-87	43	70																																																																																																																																																																																																																																																																																																																															
43	-90	57	25	-87	70	9	-80																																																																																																																																																																																																																																																																																																																															
25	-70	90	-80	43	9	-57	87																																																																																																																																																																																																																																																																																																																															
9	-25	43	-57	70	-80	87	-90																																																																																																																																																																																																																																																																																																																															
P	<table border="1"><tr><td>1</td><td>0</td><td>0</td><td>0</td><td>0</td><td>0</td><td>0</td><td>0</td></tr><tr><td>0</td><td>0</td><td>0</td><td>0</td><td>0</td><td>0</td><td>0</td><td>0</td></tr><tr><td>0</td><td>0</td><td>0</td><td>0</td><td>0</td><td>0</td><td>0</td><td>0</td></tr><tr><td>0</td><td>0</td><td>0</td><td>0</td><td>0</td><td>0</td><td>0</td><td>0</td></tr><tr><td>0</td><td>0</td><td>0</td><td>0</td><td>0</td><td>0</td><td>0</td><td>0</td></tr><tr><td>0</td><td>0</td><td>0</td><td>0</td><td>0</td><td>0</td><td>0</td><td>0</td></tr><tr><td>0</td><td>0</td><td>0</td><td>0</td><td>0</td><td>0</td><td>0</td><td>0</td></tr><tr><td>0</td><td>0</td><td>0</td><td>0</td><td>0</td><td>0</td><td>0</td><td>0</td></tr></table>	1	0	0	0	0	0	0	0	0	0	0	0	0	0	0	0	0	0	0	0	0	0	0	0	0	0	0	0	0	0	0	0	0	0	0	0	0	0	0	0	0	0	0	0	0	0	0	0	0	0	0	0	0	0	0	0	0	0	0	0	0	0	0	0	<table border="1"><tr><td>1</td><td>0</td><td>0</td><td>0</td><td>0</td><td>0</td><td>0</td><td>0</td></tr><tr><td>0</td><td>0</td><td>1</td><td>0</td><td>0</td><td>0</td><td>0</td><td>0</td></tr><tr><td>0</td><td>0</td><td>0</td><td>0</td><td>0</td><td>0</td><td>0</td><td>0</td></tr><tr><td>0</td><td>0</td><td>0</td><td>0</td><td>0</td><td>0</td><td>0</td><td>0</td></tr><tr><td>0</td><td>0</td><td>0</td><td>0</td><td>0</td><td>0</td><td>0</td><td>0</td></tr><tr><td>0</td><td>0</td><td>0</td><td>0</td><td>0</td><td>0</td><td>0</td><td>0</td></tr><tr><td>0</td><td>0</td><td>0</td><td>0</td><td>0</td><td>0</td><td>0</td><td>0</td></tr><tr><td>0</td><td>0</td><td>0</td><td>0</td><td>0</td><td>0</td><td>0</td><td>0</td></tr></table>	1	0	0	0	0	0	0	0	0	0	1	0	0	0	0	0	0	0	0	0	0	0	0	0	0	0	0	0	0	0	0	0	0	0	0	0	0	0	0	0	0	0	0	0	0	0	0	0	0	0	0	0	0	0	0	0	0	0	0	0	0	0	0	0	<table border="1"><tr><td>1</td><td>0</td><td>0</td><td>0</td><td>0</td><td>0</td><td>0</td><td>0</td></tr><tr><td>0</td><td>0</td><td>1</td><td>0</td><td>0</td><td>0</td><td>0</td><td>0</td></tr><tr><td>0</td><td>0</td><td>0</td><td>-1</td><td>0</td><td>0</td><td>0</td><td>0</td></tr><tr><td>0</td><td>0</td><td>0</td><td>0</td><td>0</td><td>0</td><td>0</td><td>0</td></tr><tr><td>0</td><td>0</td><td>0</td><td>0</td><td>0</td><td>0</td><td>0</td><td>0</td></tr><tr><td>0</td><td>0</td><td>0</td><td>0</td><td>0</td><td>0</td><td>0</td><td>0</td></tr><tr><td>0</td><td>0</td><td>0</td><td>0</td><td>0</td><td>0</td><td>0</td><td>0</td></tr><tr><td>0</td><td>0</td><td>0</td><td>0</td><td>0</td><td>0</td><td>0</td><td>0</td></tr></table>	1	0	0	0	0	0	0	0	0	0	1	0	0	0	0	0	0	0	0	-1	0	0	0	0	0	0	0	0	0	0	0	0	0	0	0	0	0	0	0	0	0	0	0	0	0	0	0	0	0	0	0	0	0	0	0	0	0	0	0	0	0	0	0	0	<table border="1"><tr><td>1</td><td>0</td><td>0</td><td>0</td><td>0</td><td>0</td><td>0</td><td>0</td></tr><tr><td>0</td><td>0</td><td>1</td><td>0</td><td>0</td><td>0</td><td>0</td><td>0</td></tr><tr><td>0</td><td>0</td><td>0</td><td>-1</td><td>0</td><td>0</td><td>0</td><td>0</td></tr><tr><td>0</td><td>0</td><td>0</td><td>0</td><td>0</td><td>0</td><td>0</td><td>0</td></tr><tr><td>0</td><td>0</td><td>0</td><td>0</td><td>0</td><td>0</td><td>0</td><td>0</td></tr><tr><td>0</td><td>0</td><td>0</td><td>0</td><td>0</td><td>0</td><td>0</td><td>0</td></tr><tr><td>0</td><td>0</td><td>0</td><td>0</td><td>0</td><td>0</td><td>0</td><td>0</td></tr><tr><td>0</td><td>0</td><td>0</td><td>0</td><td>0</td><td>0</td><td>0</td><td>0</td></tr></table>	1	0	0	0	0	0	0	0	0	0	1	0	0	0	0	0	0	0	0	-1	0	0	0	0	0	0	0	0	0	0	0	0	0	0	0	0	0	0	0	0	0	0	0	0	0	0	0	0	0	0	0	0	0	0	0	0	0	0	0	0	0	0	0	0	P	<table border="1"><tr><td>1</td><td>0</td><td>0</td><td>0</td><td>0</td><td>0</td><td>0</td><td>0</td></tr><tr><td>0</td><td>0</td><td>1</td><td>0</td><td>0</td><td>0</td><td>0</td><td>0</td></tr><tr><td>0</td><td>0</td><td>0</td><td>-1</td><td>0</td><td>0</td><td>0</td><td>0</td></tr><tr><td>0</td><td>0</td><td>0</td><td>0</td><td>0</td><td>0</td><td>0</td><td>0</td></tr><tr><td>0</td><td>0</td><td>0</td><td>0</td><td>0</td><td>0</td><td>0</td><td>0</td></tr><tr><td>0</td><td>0</td><td>0</td><td>0</td><td>0</td><td>0</td><td>0</td><td>0</td></tr><tr><td>0</td><td>0</td><td>0</td><td>0</td><td>0</td><td>0</td><td>0</td><td>0</td></tr><tr><td>0</td><td>0</td><td>0</td><td>0</td><td>0</td><td>0</td><td>0</td><td>0</td></tr></table>	1	0	0	0	0	0	0	0	0	0	1	0	0	0	0	0	0	0	0	-1	0	0	0	0	0	0	0	0	0	0	0	0	0	0	0	0	0	0	0	0	0	0	0	0	0	0	0	0	0	0	0	0	0	0	0	0	0	0	0	0	0	0	0	0
1	0	0	0	0	0	0	0																																																																																																																																																																																																																																																																																																																															
0	0	0	0	0	0	0	0																																																																																																																																																																																																																																																																																																																															
0	0	0	0	0	0	0	0																																																																																																																																																																																																																																																																																																																															
0	0	0	0	0	0	0	0																																																																																																																																																																																																																																																																																																																															
0	0	0	0	0	0	0	0																																																																																																																																																																																																																																																																																																																															
0	0	0	0	0	0	0	0																																																																																																																																																																																																																																																																																																																															
0	0	0	0	0	0	0	0																																																																																																																																																																																																																																																																																																																															
0	0	0	0	0	0	0	0																																																																																																																																																																																																																																																																																																																															
1	0	0	0	0	0	0	0																																																																																																																																																																																																																																																																																																																															
0	0	1	0	0	0	0	0																																																																																																																																																																																																																																																																																																																															
0	0	0	0	0	0	0	0																																																																																																																																																																																																																																																																																																																															
0	0	0	0	0	0	0	0																																																																																																																																																																																																																																																																																																																															
0	0	0	0	0	0	0	0																																																																																																																																																																																																																																																																																																																															
0	0	0	0	0	0	0	0																																																																																																																																																																																																																																																																																																																															
0	0	0	0	0	0	0	0																																																																																																																																																																																																																																																																																																																															
0	0	0	0	0	0	0	0																																																																																																																																																																																																																																																																																																																															
1	0	0	0	0	0	0	0																																																																																																																																																																																																																																																																																																																															
0	0	1	0	0	0	0	0																																																																																																																																																																																																																																																																																																																															
0	0	0	-1	0	0	0	0																																																																																																																																																																																																																																																																																																																															
0	0	0	0	0	0	0	0																																																																																																																																																																																																																																																																																																																															
0	0	0	0	0	0	0	0																																																																																																																																																																																																																																																																																																																															
0	0	0	0	0	0	0	0																																																																																																																																																																																																																																																																																																																															
0	0	0	0	0	0	0	0																																																																																																																																																																																																																																																																																																																															
0	0	0	0	0	0	0	0																																																																																																																																																																																																																																																																																																																															
1	0	0	0	0	0	0	0																																																																																																																																																																																																																																																																																																																															
0	0	1	0	0	0	0	0																																																																																																																																																																																																																																																																																																																															
0	0	0	-1	0	0	0	0																																																																																																																																																																																																																																																																																																																															
0	0	0	0	0	0	0	0																																																																																																																																																																																																																																																																																																																															
0	0	0	0	0	0	0	0																																																																																																																																																																																																																																																																																																																															
0	0	0	0	0	0	0	0																																																																																																																																																																																																																																																																																																																															
0	0	0	0	0	0	0	0																																																																																																																																																																																																																																																																																																																															
0	0	0	0	0	0	0	0																																																																																																																																																																																																																																																																																																																															
1	0	0	0	0	0	0	0																																																																																																																																																																																																																																																																																																																															
0	0	1	0	0	0	0	0																																																																																																																																																																																																																																																																																																																															
0	0	0	-1	0	0	0	0																																																																																																																																																																																																																																																																																																																															
0	0	0	0	0	0	0	0																																																																																																																																																																																																																																																																																																																															
0	0	0	0	0	0	0	0																																																																																																																																																																																																																																																																																																																															
0	0	0	0	0	0	0	0																																																																																																																																																																																																																																																																																																																															
0	0	0	0	0	0	0	0																																																																																																																																																																																																																																																																																																																															
0	0	0	0	0	0	0	0																																																																																																																																																																																																																																																																																																																															
PA	<table border="1"><tr><td>90</td><td>87</td><td>80</td><td>70</td><td>57</td><td>43</td><td>25</td><td>9</td></tr><tr><td>0</td><td>0</td><td>0</td><td>0</td><td>0</td><td>0</td><td>0</td><td>0</td></tr><tr><td>0</td><td>0</td><td>0</td><td>0</td><td>0</td><td>0</td><td>0</td><td>0</td></tr><tr><td>0</td><td>0</td><td>0</td><td>0</td><td>0</td><td>0</td><td>0</td><td>0</td></tr><tr><td>0</td><td>0</td><td>0</td><td>0</td><td>0</td><td>0</td><td>0</td><td>0</td></tr><tr><td>0</td><td>0</td><td>0</td><td>0</td><td>0</td><td>0</td><td>0</td><td>0</td></tr><tr><td>0</td><td>0</td><td>0</td><td>0</td><td>0</td><td>0</td><td>0</td><td>0</td></tr><tr><td>0</td><td>0</td><td>0</td><td>0</td><td>0</td><td>0</td><td>0</td><td>0</td></tr></table>	90	87	80	70	57	43	25	9	0	0	0	0	0	0	0	0	0	0	0	0	0	0	0	0	0	0	0	0	0	0	0	0	0	0	0	0	0	0	0	0	0	0	0	0	0	0	0	0	0	0	0	0	0	0	0	0	0	0	0	0	0	0	0	0	<table border="1"><tr><td>90</td><td>87</td><td>80</td><td>70</td><td>57</td><td>43</td><td>25</td><td>9</td></tr><tr><td>80</td><td>9</td><td>-70</td><td>-87</td><td>-25</td><td>57</td><td>90</td><td>43</td></tr><tr><td>0</td><td>0</td><td>0</td><td>0</td><td>0</td><td>0</td><td>0</td><td>0</td></tr><tr><td>0</td><td>0</td><td>0</td><td>0</td><td>0</td><td>0</td><td>0</td><td>0</td></tr><tr><td>0</td><td>0</td><td>0</td><td>0</td><td>0</td><td>0</td><td>0</td><td>0</td></tr><tr><td>0</td><td>0</td><td>0</td><td>0</td><td>0</td><td>0</td><td>0</td><td>0</td></tr><tr><td>0</td><td>0</td><td>0</td><td>0</td><td>0</td><td>0</td><td>0</td><td>0</td></tr><tr><td>0</td><td>0</td><td>0</td><td>0</td><td>0</td><td>0</td><td>0</td><td>0</td></tr></table>	90	87	80	70	57	43	25	9	80	9	-70	-87	-25	57	90	43	0	0	0	0	0	0	0	0	0	0	0	0	0	0	0	0	0	0	0	0	0	0	0	0	0	0	0	0	0	0	0	0	0	0	0	0	0	0	0	0	0	0	0	0	0	0	0	0	<table border="1"><tr><td>90</td><td>87</td><td>80</td><td>70</td><td>57</td><td>43</td><td>25</td><td>9</td></tr><tr><td>80</td><td>9</td><td>-70</td><td>-87</td><td>-25</td><td>57</td><td>90</td><td>43</td></tr><tr><td>-70</td><td>-43</td><td>87</td><td>-9</td><td>-90</td><td>-25</td><td>80</td><td>57</td></tr><tr><td>0</td><td>0</td><td>0</td><td>0</td><td>0</td><td>0</td><td>0</td><td>0</td></tr><tr><td>0</td><td>0</td><td>0</td><td>0</td><td>0</td><td>0</td><td>0</td><td>0</td></tr><tr><td>0</td><td>0</td><td>0</td><td>0</td><td>0</td><td>0</td><td>0</td><td>0</td></tr><tr><td>0</td><td>0</td><td>0</td><td>0</td><td>0</td><td>0</td><td>0</td><td>0</td></tr><tr><td>0</td><td>0</td><td>0</td><td>0</td><td>0</td><td>0</td><td>0</td><td>0</td></tr></table>	90	87	80	70	57	43	25	9	80	9	-70	-87	-25	57	90	43	-70	-43	87	-9	-90	-25	80	57	0	0	0	0	0	0	0	0	0	0	0	0	0	0	0	0	0	0	0	0	0	0	0	0	0	0	0	0	0	0	0	0	0	0	0	0	0	0	0	0	<table border="1"><tr><td>90</td><td>87</td><td>80</td><td>70</td><td>57</td><td>43</td><td>25</td><td>9</td></tr><tr><td>80</td><td>9</td><td>-70</td><td>-87</td><td>-25</td><td>57</td><td>90</td><td>43</td></tr><tr><td>-70</td><td>-43</td><td>87</td><td>-9</td><td>-90</td><td>-25</td><td>80</td><td>57</td></tr><tr><td>87</td><td>57</td><td>9</td><td>-43</td><td>-80</td><td>-90</td><td>-70</td><td>-25</td></tr><tr><td>0</td><td>0</td><td>0</td><td>0</td><td>0</td><td>0</td><td>0</td><td>0</td></tr><tr><td>0</td><td>0</td><td>0</td><td>0</td><td>0</td><td>0</td><td>0</td><td>0</td></tr><tr><td>0</td><td>0</td><td>0</td><td>0</td><td>0</td><td>0</td><td>0</td><td>0</td></tr><tr><td>0</td><td>0</td><td>0</td><td>0</td><td>0</td><td>0</td><td>0</td><td>0</td></tr></table>	90	87	80	70	57	43	25	9	80	9	-70	-87	-25	57	90	43	-70	-43	87	-9	-90	-25	80	57	87	57	9	-43	-80	-90	-70	-25	0	0	0	0	0	0	0	0	0	0	0	0	0	0	0	0	0	0	0	0	0	0	0	0	0	0	0	0	0	0	0	0	PA	<table border="1"><tr><td>90</td><td>87</td><td>80</td><td>70</td><td>57</td><td>43</td><td>25</td><td>9</td></tr><tr><td>80</td><td>9</td><td>-70</td><td>-87</td><td>-25</td><td>57</td><td>90</td><td>43</td></tr><tr><td>-70</td><td>-43</td><td>87</td><td>-9</td><td>-90</td><td>-25</td><td>80</td><td>57</td></tr><tr><td>87</td><td>57</td><td>9</td><td>-43</td><td>-80</td><td>-90</td><td>-70</td><td>-25</td></tr><tr><td>9</td><td>-25</td><td>43</td><td>-57</td><td>70</td><td>-80</td><td>87</td><td>-90</td></tr><tr><td>43</td><td>-90</td><td>57</td><td>25</td><td>-87</td><td>70</td><td>9</td><td>-80</td></tr><tr><td>57</td><td>-80</td><td>-25</td><td>90</td><td>-9</td><td>-87</td><td>43</td><td>70</td></tr><tr><td>-25</td><td>-70</td><td>90</td><td>-80</td><td>43</td><td>9</td><td>-57</td><td>87</td></tr></table>	90	87	80	70	57	43	25	9	80	9	-70	-87	-25	57	90	43	-70	-43	87	-9	-90	-25	80	57	87	57	9	-43	-80	-90	-70	-25	9	-25	43	-57	70	-80	87	-90	43	-90	57	25	-87	70	9	-80	57	-80	-25	90	-9	-87	43	70	-25	-70	90	-80	43	9	-57	87
90	87	80	70	57	43	25	9																																																																																																																																																																																																																																																																																																																															
0	0	0	0	0	0	0	0																																																																																																																																																																																																																																																																																																																															
0	0	0	0	0	0	0	0																																																																																																																																																																																																																																																																																																																															
0	0	0	0	0	0	0	0																																																																																																																																																																																																																																																																																																																															
0	0	0	0	0	0	0	0																																																																																																																																																																																																																																																																																																																															
0	0	0	0	0	0	0	0																																																																																																																																																																																																																																																																																																																															
0	0	0	0	0	0	0	0																																																																																																																																																																																																																																																																																																																															
0	0	0	0	0	0	0	0																																																																																																																																																																																																																																																																																																																															
90	87	80	70	57	43	25	9																																																																																																																																																																																																																																																																																																																															
80	9	-70	-87	-25	57	90	43																																																																																																																																																																																																																																																																																																																															
0	0	0	0	0	0	0	0																																																																																																																																																																																																																																																																																																																															
0	0	0	0	0	0	0	0																																																																																																																																																																																																																																																																																																																															
0	0	0	0	0	0	0	0																																																																																																																																																																																																																																																																																																																															
0	0	0	0	0	0	0	0																																																																																																																																																																																																																																																																																																																															
0	0	0	0	0	0	0	0																																																																																																																																																																																																																																																																																																																															
0	0	0	0	0	0	0	0																																																																																																																																																																																																																																																																																																																															
90	87	80	70	57	43	25	9																																																																																																																																																																																																																																																																																																																															
80	9	-70	-87	-25	57	90	43																																																																																																																																																																																																																																																																																																																															
-70	-43	87	-9	-90	-25	80	57																																																																																																																																																																																																																																																																																																																															
0	0	0	0	0	0	0	0																																																																																																																																																																																																																																																																																																																															
0	0	0	0	0	0	0	0																																																																																																																																																																																																																																																																																																																															
0	0	0	0	0	0	0	0																																																																																																																																																																																																																																																																																																																															
0	0	0	0	0	0	0	0																																																																																																																																																																																																																																																																																																																															
0	0	0	0	0	0	0	0																																																																																																																																																																																																																																																																																																																															
90	87	80	70	57	43	25	9																																																																																																																																																																																																																																																																																																																															
80	9	-70	-87	-25	57	90	43																																																																																																																																																																																																																																																																																																																															
-70	-43	87	-9	-90	-25	80	57																																																																																																																																																																																																																																																																																																																															
87	57	9	-43	-80	-90	-70	-25																																																																																																																																																																																																																																																																																																																															
0	0	0	0	0	0	0	0																																																																																																																																																																																																																																																																																																																															
0	0	0	0	0	0	0	0																																																																																																																																																																																																																																																																																																																															
0	0	0	0	0	0	0	0																																																																																																																																																																																																																																																																																																																															
0	0	0	0	0	0	0	0																																																																																																																																																																																																																																																																																																																															
90	87	80	70	57	43	25	9																																																																																																																																																																																																																																																																																																																															
80	9	-70	-87	-25	57	90	43																																																																																																																																																																																																																																																																																																																															
-70	-43	87	-9	-90	-25	80	57																																																																																																																																																																																																																																																																																																																															
87	57	9	-43	-80	-90	-70	-25																																																																																																																																																																																																																																																																																																																															
9	-25	43	-57	70	-80	87	-90																																																																																																																																																																																																																																																																																																																															
43	-90	57	25	-87	70	9	-80																																																																																																																																																																																																																																																																																																																															
57	-80	-25	90	-9	-87	43	70																																																																																																																																																																																																																																																																																																																															
-25	-70	90	-80	43	9	-57	87																																																																																																																																																																																																																																																																																																																															
P^T	<table border="1"><tr><td>1</td><td>0</td><td>0</td><td>0</td><td>0</td><td>0</td><td>0</td><td>0</td></tr><tr><td>0</td><td>0</td><td>0</td><td>0</td><td>0</td><td>0</td><td>0</td><td>0</td></tr><tr><td>0</td><td>0</td><td>0</td><td>0</td><td>0</td><td>0</td><td>0</td><td>0</td></tr><tr><td>0</td><td>0</td><td>0</td><td>0</td><td>0</td><td>0</td><td>0</td><td>0</td></tr><tr><td>0</td><td>0</td><td>0</td><td>0</td><td>0</td><td>0</td><td>0</td><td>0</td></tr><tr><td>0</td><td>0</td><td>0</td><td>0</td><td>0</td><td>0</td><td>0</td><td>0</td></tr><tr><td>0</td><td>0</td><td>0</td><td>0</td><td>0</td><td>0</td><td>0</td><td>0</td></tr><tr><td>0</td><td>0</td><td>0</td><td>0</td><td>0</td><td>0</td><td>0</td><td>0</td></tr></table>	1	0	0	0	0	0	0	0	0	0	0	0	0	0	0	0	0	0	0	0	0	0	0	0	0	0	0	0	0	0	0	0	0	0	0	0	0	0	0	0	0	0	0	0	0	0	0	0	0	0	0	0	0	0	0	0	0	0	0	0	0	0	0	0	<table border="1"><tr><td>1</td><td>0</td><td>0</td><td>0</td><td>0</td><td>0</td><td>0</td><td>0</td></tr><tr><td>0</td><td>0</td><td>0</td><td>0</td><td>0</td><td>0</td><td>0</td><td>0</td></tr><tr><td>0</td><td>1</td><td>0</td><td>0</td><td>0</td><td>0</td><td>0</td><td>0</td></tr><tr><td>0</td><td>0</td><td>0</td><td>0</td><td>0</td><td>0</td><td>0</td><td>0</td></tr><tr><td>0</td><td>0</td><td>0</td><td>0</td><td>0</td><td>0</td><td>0</td><td>0</td></tr><tr><td>0</td><td>0</td><td>0</td><td>0</td><td>0</td><td>0</td><td>0</td><td>0</td></tr><tr><td>0</td><td>0</td><td>0</td><td>0</td><td>0</td><td>0</td><td>0</td><td>0</td></tr><tr><td>0</td><td>0</td><td>0</td><td>0</td><td>0</td><td>0</td><td>0</td><td>0</td></tr></table>	1	0	0	0	0	0	0	0	0	0	0	0	0	0	0	0	0	1	0	0	0	0	0	0	0	0	0	0	0	0	0	0	0	0	0	0	0	0	0	0	0	0	0	0	0	0	0	0	0	0	0	0	0	0	0	0	0	0	0	0	0	0	0	0	<table border="1"><tr><td>1</td><td>0</td><td>0</td><td>0</td><td>0</td><td>0</td><td>0</td><td>0</td></tr><tr><td>0</td><td>0</td><td>0</td><td>0</td><td>0</td><td>0</td><td>0</td><td>0</td></tr><tr><td>0</td><td>1</td><td>0</td><td>0</td><td>0</td><td>0</td><td>0</td><td>0</td></tr><tr><td>0</td><td>0</td><td>-1</td><td>0</td><td>0</td><td>0</td><td>0</td><td>0</td></tr><tr><td>0</td><td>0</td><td>0</td><td>0</td><td>0</td><td>0</td><td>0</td><td>0</td></tr><tr><td>0</td><td>0</td><td>0</td><td>0</td><td>0</td><td>0</td><td>0</td><td>0</td></tr><tr><td>0</td><td>0</td><td>0</td><td>0</td><td>0</td><td>0</td><td>0</td><td>0</td></tr><tr><td>0</td><td>0</td><td>0</td><td>0</td><td>0</td><td>0</td><td>0</td><td>0</td></tr></table>	1	0	0	0	0	0	0	0	0	0	0	0	0	0	0	0	0	1	0	0	0	0	0	0	0	0	-1	0	0	0	0	0	0	0	0	0	0	0	0	0	0	0	0	0	0	0	0	0	0	0	0	0	0	0	0	0	0	0	0	0	0	0	0	0	<table border="1"><tr><td>1</td><td>0</td><td>0</td><td>0</td><td>0</td><td>0</td><td>0</td><td>0</td></tr><tr><td>0</td><td>0</td><td>0</td><td>1</td><td>0</td><td>0</td><td>0</td><td>0</td></tr><tr><td>0</td><td>0</td><td>0</td><td>-1</td><td>0</td><td>0</td><td>0</td><td>0</td></tr><tr><td>0</td><td>0</td><td>0</td><td>0</td><td>0</td><td>0</td><td>0</td><td>0</td></tr><tr><td>0</td><td>0</td><td>0</td><td>0</td><td>0</td><td>0</td><td>0</td><td>0</td></tr><tr><td>0</td><td>0</td><td>0</td><td>0</td><td>0</td><td>0</td><td>0</td><td>0</td></tr><tr><td>0</td><td>0</td><td>0</td><td>0</td><td>0</td><td>0</td><td>0</td><td>0</td></tr><tr><td>0</td><td>0</td><td>0</td><td>0</td><td>0</td><td>0</td><td>0</td><td>0</td></tr></table>	1	0	0	0	0	0	0	0	0	0	0	1	0	0	0	0	0	0	0	-1	0	0	0	0	0	0	0	0	0	0	0	0	0	0	0	0	0	0	0	0	0	0	0	0	0	0	0	0	0	0	0	0	0	0	0	0	0	0	0	0	0	0	0	0	P^T	<table border="1"><tr><td>1</td><td>0</td><td>0</td><td>0</td><td>0</td><td>0</td><td>0</td><td>0</td></tr><tr><td>0</td><td>0</td><td>0</td><td>1</td><td>0</td><td>0</td><td>0</td><td>0</td></tr><tr><td>0</td><td>0</td><td>0</td><td>0</td><td>0</td><td>0</td><td>0</td><td>0</td></tr><tr><td>0</td><td>1</td><td>0</td><td>0</td><td>0</td><td>0</td><td>0</td><td>0</td></tr><tr><td>0</td><td>0</td><td>-1</td><td>0</td><td>0</td><td>0</td><td>0</td><td>0</td></tr><tr><td>0</td><td>0</td><td>0</td><td>0</td><td>0</td><td>0</td><td>0</td><td>0</td></tr><tr><td>0</td><td>0</td><td>0</td><td>0</td><td>0</td><td>0</td><td>0</td><td>0</td></tr><tr><td>0</td><td>0</td><td>0</td><td>0</td><td>0</td><td>0</td><td>0</td><td>0</td></tr></table>	1	0	0	0	0	0	0	0	0	0	0	1	0	0	0	0	0	0	0	0	0	0	0	0	0	1	0	0	0	0	0	0	0	0	-1	0	0	0	0	0	0	0	0	0	0	0	0	0	0	0	0	0	0	0	0	0	0	0	0	0	0	0	0	0
1	0	0	0	0	0	0	0																																																																																																																																																																																																																																																																																																																															
0	0	0	0	0	0	0	0																																																																																																																																																																																																																																																																																																																															
0	0	0	0	0	0	0	0																																																																																																																																																																																																																																																																																																																															
0	0	0	0	0	0	0	0																																																																																																																																																																																																																																																																																																																															
0	0	0	0	0	0	0	0																																																																																																																																																																																																																																																																																																																															
0	0	0	0	0	0	0	0																																																																																																																																																																																																																																																																																																																															
0	0	0	0	0	0	0	0																																																																																																																																																																																																																																																																																																																															
0	0	0	0	0	0	0	0																																																																																																																																																																																																																																																																																																																															
1	0	0	0	0	0	0	0																																																																																																																																																																																																																																																																																																																															
0	0	0	0	0	0	0	0																																																																																																																																																																																																																																																																																																																															
0	1	0	0	0	0	0	0																																																																																																																																																																																																																																																																																																																															
0	0	0	0	0	0	0	0																																																																																																																																																																																																																																																																																																																															
0	0	0	0	0	0	0	0																																																																																																																																																																																																																																																																																																																															
0	0	0	0	0	0	0	0																																																																																																																																																																																																																																																																																																																															
0	0	0	0	0	0	0	0																																																																																																																																																																																																																																																																																																																															
0	0	0	0	0	0	0	0																																																																																																																																																																																																																																																																																																																															
1	0	0	0	0	0	0	0																																																																																																																																																																																																																																																																																																																															
0	0	0	0	0	0	0	0																																																																																																																																																																																																																																																																																																																															
0	1	0	0	0	0	0	0																																																																																																																																																																																																																																																																																																																															
0	0	-1	0	0	0	0	0																																																																																																																																																																																																																																																																																																																															
0	0	0	0	0	0	0	0																																																																																																																																																																																																																																																																																																																															
0	0	0	0	0	0	0	0																																																																																																																																																																																																																																																																																																																															
0	0	0	0	0	0	0	0																																																																																																																																																																																																																																																																																																																															
0	0	0	0	0	0	0	0																																																																																																																																																																																																																																																																																																																															
1	0	0	0	0	0	0	0																																																																																																																																																																																																																																																																																																																															
0	0	0	1	0	0	0	0																																																																																																																																																																																																																																																																																																																															
0	0	0	-1	0	0	0	0																																																																																																																																																																																																																																																																																																																															
0	0	0	0	0	0	0	0																																																																																																																																																																																																																																																																																																																															
0	0	0	0	0	0	0	0																																																																																																																																																																																																																																																																																																																															
0	0	0	0	0	0	0	0																																																																																																																																																																																																																																																																																																																															
0	0	0	0	0	0	0	0																																																																																																																																																																																																																																																																																																																															
0	0	0	0	0	0	0	0																																																																																																																																																																																																																																																																																																																															
1	0	0	0	0	0	0	0																																																																																																																																																																																																																																																																																																																															
0	0	0	1	0	0	0	0																																																																																																																																																																																																																																																																																																																															
0	0	0	0	0	0	0	0																																																																																																																																																																																																																																																																																																																															
0	1	0	0	0	0	0	0																																																																																																																																																																																																																																																																																																																															
0	0	-1	0	0	0	0	0																																																																																																																																																																																																																																																																																																																															
0	0	0	0	0	0	0	0																																																																																																																																																																																																																																																																																																																															
0	0	0	0	0	0	0	0																																																																																																																																																																																																																																																																																																																															
0	0	0	0	0	0	0	0																																																																																																																																																																																																																																																																																																																															
C	<table border="1"><tr><td>90</td><td>0</td><td>0</td><td>0</td><td>0</td><td>0</td><td>0</td><td>0</td></tr><tr><td>0</td><td>0</td><td>0</td><td>0</td><td>0</td><td>0</td><td>0</td><td>0</td></tr><tr><td>0</td><td>0</td><td>0</td><td>0</td><td>0</td><td>0</td><td>0</td><td>0</td></tr><tr><td>0</td><td>0</td><td>0</td><td>0</td><td>0</td><td>0</td><td>0</td><td>0</td></tr><tr><td>0</td><td>0</td><td>0</td><td>0</td><td>0</td><td>0</td><td>0</td><td>0</td></tr><tr><td>0</td><td>0</td><td>0</td><td>0</td><td>0</td><td>0</td><td>0</td><td>0</td></tr><tr><td>0</td><td>0</td><td>0</td><td>0</td><td>0</td><td>0</td><td>0</td><td>0</td></tr><tr><td>0</td><td>0</td><td>0</td><td>0</td><td>0</td><td>0</td><td>0</td><td>0</td></tr></table>	90	0	0	0	0	0	0	0	0	0	0	0	0	0	0	0	0	0	0	0	0	0	0	0	0	0	0	0	0	0	0	0	0	0	0	0	0	0	0	0	0	0	0	0	0	0	0	0	0	0	0	0	0	0	0	0	0	0	0	0	0	0	0	0	<table border="1"><tr><td>90</td><td>80</td><td>0</td><td>0</td><td>0</td><td>0</td><td>0</td><td>0</td></tr><tr><td>80</td><td>-70</td><td>0</td><td>0</td><td>0</td><td>0</td><td>0</td><td>0</td></tr><tr><td>0</td><td>0</td><td>0</td><td>0</td><td>0</td><td>0</td><td>0</td><td>0</td></tr><tr><td>0</td><td>0</td><td>0</td><td>0</td><td>0</td><td>0</td><td>0</td><td>0</td></tr><tr><td>0</td><td>0</td><td>0</td><td>0</td><td>0</td><td>0</td><td>0</td><td>0</td></tr><tr><td>0</td><td>0</td><td>0</td><td>0</td><td>0</td><td>0</td><td>0</td><td>0</td></tr><tr><td>0</td><td>0</td><td>0</td><td>0</td><td>0</td><td>0</td><td>0</td><td>0</td></tr><tr><td>0</td><td>0</td><td>0</td><td>0</td><td>0</td><td>0</td><td>0</td><td>0</td></tr></table>	90	80	0	0	0	0	0	0	80	-70	0	0	0	0	0	0	0	0	0	0	0	0	0	0	0	0	0	0	0	0	0	0	0	0	0	0	0	0	0	0	0	0	0	0	0	0	0	0	0	0	0	0	0	0	0	0	0	0	0	0	0	0	0	0	<table border="1"><tr><td>90</td><td>80</td><td>-70</td><td>0</td><td>0</td><td>0</td><td>0</td><td>0</td></tr><tr><td>80</td><td>-70</td><td>87</td><td>0</td><td>0</td><td>0</td><td>0</td><td>0</td></tr><tr><td>-70</td><td>87</td><td>9</td><td>0</td><td>0</td><td>0</td><td>0</td><td>0</td></tr><tr><td>0</td><td>0</td><td>0</td><td>0</td><td>0</td><td>0</td><td>0</td><td>0</td></tr><tr><td>0</td><td>0</td><td>0</td><td>0</td><td>0</td><td>0</td><td>0</td><td>0</td></tr><tr><td>0</td><td>0</td><td>0</td><td>0</td><td>0</td><td>0</td><td>0</td><td>0</td></tr><tr><td>0</td><td>0</td><td>0</td><td>0</td><td>0</td><td>0</td><td>0</td><td>0</td></tr><tr><td>0</td><td>0</td><td>0</td><td>0</td><td>0</td><td>0</td><td>0</td><td>0</td></tr></table>	90	80	-70	0	0	0	0	0	80	-70	87	0	0	0	0	0	-70	87	9	0	0	0	0	0	0	0	0	0	0	0	0	0	0	0	0	0	0	0	0	0	0	0	0	0	0	0	0	0	0	0	0	0	0	0	0	0	0	0	0	0	0	0	0	0	<table border="1"><tr><td>90</td><td>80</td><td>-70</td><td>87</td><td>0</td><td>0</td><td>0</td><td>0</td></tr><tr><td>80</td><td>-70</td><td>87</td><td>9</td><td>0</td><td>0</td><td>0</td><td>0</td></tr><tr><td>-70</td><td>87</td><td>9</td><td>43</td><td>0</td><td>0</td><td>0</td><td>0</td></tr><tr><td>87</td><td>9</td><td>43</td><td>57</td><td>0</td><td>0</td><td>0</td><td>0</td></tr><tr><td>0</td><td>0</td><td>0</td><td>0</td><td>0</td><td>0</td><td>0</td><td>0</td></tr><tr><td>0</td><td>0</td><td>0</td><td>0</td><td>0</td><td>0</td><td>0</td><td>0</td></tr><tr><td>0</td><td>0</td><td>0</td><td>0</td><td>0</td><td>0</td><td>0</td><td>0</td></tr><tr><td>0</td><td>0</td><td>0</td><td>0</td><td>0</td><td>0</td><td>0</td><td>0</td></tr></table>	90	80	-70	87	0	0	0	0	80	-70	87	9	0	0	0	0	-70	87	9	43	0	0	0	0	87	9	43	57	0	0	0	0	0	0	0	0	0	0	0	0	0	0	0	0	0	0	0	0	0	0	0	0	0	0	0	0	0	0	0	0	0	0	0	0	C	<table border="1"><tr><td>90</td><td>80</td><td>-70</td><td>87</td><td>9</td><td>43</td><td>57</td><td>25</td></tr><tr><td>80</td><td>-70</td><td>87</td><td>9</td><td>43</td><td>57</td><td>-25</td><td>-90</td></tr><tr><td>-70</td><td>87</td><td>9</td><td>43</td><td>57</td><td>25</td><td>90</td><td>-80</td></tr><tr><td>87</td><td>9</td><td>43</td><td>57</td><td>-25</td><td>-90</td><td>-80</td><td>70</td></tr><tr><td>9</td><td>43</td><td>57</td><td>-25</td><td>-90</td><td>-80</td><td>70</td><td>87</td></tr><tr><td>43</td><td>57</td><td>-25</td><td>-90</td><td>-80</td><td>70</td><td>87</td><td>-9</td></tr><tr><td>57</td><td>-25</td><td>-90</td><td>-80</td><td>70</td><td>87</td><td>-9</td><td>43</td></tr><tr><td>-25</td><td>-90</td><td>-80</td><td>70</td><td>87</td><td>-9</td><td>43</td><td>-57</td></tr></table>	90	80	-70	87	9	43	57	25	80	-70	87	9	43	57	-25	-90	-70	87	9	43	57	25	90	-80	87	9	43	57	-25	-90	-80	70	9	43	57	-25	-90	-80	70	87	43	57	-25	-90	-80	70	87	-9	57	-25	-90	-80	70	87	-9	43	-25	-90	-80	70	87	-9	43	-57
90	0	0	0	0	0	0	0																																																																																																																																																																																																																																																																																																																															
0	0	0	0	0	0	0	0																																																																																																																																																																																																																																																																																																																															
0	0	0	0	0	0	0	0																																																																																																																																																																																																																																																																																																																															
0	0	0	0	0	0	0	0																																																																																																																																																																																																																																																																																																																															
0	0	0	0	0	0	0	0																																																																																																																																																																																																																																																																																																																															
0	0	0	0	0	0	0	0																																																																																																																																																																																																																																																																																																																															
0	0	0	0	0	0	0	0																																																																																																																																																																																																																																																																																																																															
0	0	0	0	0	0	0	0																																																																																																																																																																																																																																																																																																																															
90	80	0	0	0	0	0	0																																																																																																																																																																																																																																																																																																																															
80	-70	0	0	0	0	0	0																																																																																																																																																																																																																																																																																																																															
0	0	0	0	0	0	0	0																																																																																																																																																																																																																																																																																																																															
0	0	0	0	0	0	0	0																																																																																																																																																																																																																																																																																																																															
0	0	0	0	0	0	0	0																																																																																																																																																																																																																																																																																																																															
0	0	0	0	0	0	0	0																																																																																																																																																																																																																																																																																																																															
0	0	0	0	0	0	0	0																																																																																																																																																																																																																																																																																																																															
0	0	0	0	0	0	0	0																																																																																																																																																																																																																																																																																																																															
90	80	-70	0	0	0	0	0																																																																																																																																																																																																																																																																																																																															
80	-70	87	0	0	0	0	0																																																																																																																																																																																																																																																																																																																															
-70	87	9	0	0	0	0	0																																																																																																																																																																																																																																																																																																																															
0	0	0	0	0	0	0	0																																																																																																																																																																																																																																																																																																																															
0	0	0	0	0	0	0	0																																																																																																																																																																																																																																																																																																																															
0	0	0	0	0	0	0	0																																																																																																																																																																																																																																																																																																																															
0	0	0	0	0	0	0	0																																																																																																																																																																																																																																																																																																																															
0	0	0	0	0	0	0	0																																																																																																																																																																																																																																																																																																																															
90	80	-70	87	0	0	0	0																																																																																																																																																																																																																																																																																																																															
80	-70	87	9	0	0	0	0																																																																																																																																																																																																																																																																																																																															
-70	87	9	43	0	0	0	0																																																																																																																																																																																																																																																																																																																															
87	9	43	57	0	0	0	0																																																																																																																																																																																																																																																																																																																															
0	0	0	0	0	0	0	0																																																																																																																																																																																																																																																																																																																															
0	0	0	0	0	0	0	0																																																																																																																																																																																																																																																																																																																															
0	0	0	0	0	0	0	0																																																																																																																																																																																																																																																																																																																															
0	0	0	0	0	0	0	0																																																																																																																																																																																																																																																																																																																															
90	80	-70	87	9	43	57	25																																																																																																																																																																																																																																																																																																																															
80	-70	87	9	43	57	-25	-90																																																																																																																																																																																																																																																																																																																															
-70	87	9	43	57	25	90	-80																																																																																																																																																																																																																																																																																																																															
87	9	43	57	-25	-90	-80	70																																																																																																																																																																																																																																																																																																																															
9	43	57	-25	-90	-80	70	87																																																																																																																																																																																																																																																																																																																															
43	57	-25	-90	-80	70	87	-9																																																																																																																																																																																																																																																																																																																															
57	-25	-90	-80	70	87	-9	43																																																																																																																																																																																																																																																																																																																															
-25	-90	-80	70	87	-9	43	-57																																																																																																																																																																																																																																																																																																																															

The above solution leads to a signed permutation matrix of P_8 , which transforms A_8 to a signed anti-circulant C_8 . This 8×8 matrix-vector product can be solved with 27 multiplications instead of 64 based on a recursive, circulant solver algorithm.

Similarly, for A_{16} with this method we can obtain C_{16} , which requires 81 multiplications to solve the 16×16 matrix-vector product instead of 256:

90	88	31	90	67	-78	82	54	4	22	85	-13	61	46	38	73
88	31	90	67	-78	82	54	4	22	85	-13	61	46	38	73	90
31	90	67	-78	82	54	4	22	85	-13	61	46	38	73	90	88
90	67	-78	82	54	4	22	85	-13	61	46	38	73	90	88	31
67	-78	82	54	4	22	85	-13	61	46	3					

Other permutation matrices

Although for the algorithm to work one signed P_n permutation matrix was enough to find with the spreadsheet method, some patterns started revealing during this manual process of building up various permutation matrices. It turned out that there exist several permutations that give solutions, while some do not. For example $P_{1,1} = 1$, then $P_{2,4} = 1$ does not lead to any solution for A_8 above and it *closes* the circle after 4 steps. To systematically determine all possible signed permutation matrices that the result of $C=PAP^{-1}$ is in a circular form were divided into two parts:

- First with the positive odd DCT matrix $|A_n|$, find all positive P permutation matrices from $n!$ possibilities that arranges elements of $|C|$ into the desired circular order. The results are several *positive base permutations* and their cyclic permutations.
- Then for A_n and for each positive base permutation, determine signs from 2^n possibilities. The results are several *signed base permutations* and their signed-cyclic rotations. These are the final solutions for the algorithm and basis for code generation obtained programmatically and by mathematical deduction.

Permutation vector and mapping

For convenience, in the rest of this paper a specific signed permutation matrix P is denoted by the p permutation vector. The permutation vector contains column indices for each row where the permutation matrix has a positive 1 value – and negative column indices where the permutation matrix has a negative 1 value. When solving $C(Px)$ this is also equivalent to mapping the input vector in proper order and sign before entering the matrix multiplication. The mapping (m) is simply the zero-based equivalent of p . For example:

$$P = \begin{bmatrix} 1 & 0 & 0 & 0 \\ 0 & 0 & -1 & 0 \\ 0 & 0 & 0 & 1 \\ 0 & -1 & 0 & 0 \end{bmatrix} \leftarrow \begin{pmatrix} 1 \\ -3 \\ 4 \\ -2 \end{pmatrix} \leftarrow p = (1, -3, 4, -2) \quad CPx = CP \begin{pmatrix} x_0 \\ x_1 \\ x_2 \\ x_3 \end{pmatrix} \xrightarrow{m=(0,-2,3,-1)} = C \begin{pmatrix} x_0 \\ -x_2 \\ x_3 \\ -x_1 \end{pmatrix}$$

a) Positive base permutation vectors

These results have been derived by the spreadsheet method with a positive $|A_n|$ matrix. A *base permutation vector* is a specific permutation vector starting with 1 (that is $P_{1,1} = 1$). The table shows all the positive base permutation vectors that $C=PAP^{-1}$ is in a circular form. There were 2 different base permutation vectors for 4×4 , 4 vectors for 8×8 and 8 vectors for the 16×16 $|A_n|$ odd DCT matrices:

$ p _{n=4}$				$ p _{n=8}$								$ p _{n=16}$															
1	2	3	4	1	2	3	4	5	6	7	8	1	2	3	4	5	6	7	8	9	10	11	12	13	14	15	16
1	2	4	3	1	2	5	3	8	7	4	6	1	2	5	14	9	7	13	6	16	15	12	3	8	10	4	11
1	3	4	2	1	3	4	2	8	6	5	7	1	3	13	2	8	6	5	10	16	14	4	15	9	11	12	7
				1	6	4	7	8	3	5	2	1	6	4	7	8	14	12	2	16	11	13	10	9	3	5	15
				1	7	5	6	8	2	4	3	1	7	12	11	9	15	4	14	16	10	5	6	8	2	13	3
								1	10	12	6	9	2	4	3	16	7	5	11	8	15	13	14				
								1	11	4	10	8	3	12	15	16	6	13	7	9	14	5	2				
								1	14	13	15	8	11	5	7	16	3	4	2	9	6	12	10				
								1	15	5	3	9	10	13	11	16	2	12	14	8	7	4	6				

Cyclic permutations of the positive base vector

Cycling rows of a positive P permutation matrix keeps the circular structure of the resulting $|C|$ matrix (empirical result). This is equivalent to cyclic permutations of the \mathbf{p} vector. Below is the result of all 4 cyclic permutations of positive $\mathbf{p} = (1, 2, 4, 3)$. Note that half of the resulting $|C|$ matrices are the same and that only half of the original matrix values can appear along the main anti-diagonal (here either 50 or 75):

 A 	<table border="1"><tr><td>89</td><td>75</td><td>50</td><td>18</td></tr><tr><td>75</td><td>18</td><td>89</td><td>50</td></tr><tr><td>50</td><td>89</td><td>18</td><td>75</td></tr><tr><td>18</td><td>50</td><td>75</td><td>89</td></tr></table>	89	75	50	18	75	18	89	50	50	89	18	75	18	50	75	89	<table border="1"><tr><td>89</td><td>75</td><td>50</td><td>18</td></tr><tr><td>75</td><td>18</td><td>89</td><td>50</td></tr><tr><td>50</td><td>89</td><td>18</td><td>75</td></tr><tr><td>18</td><td>50</td><td>75</td><td>89</td></tr></table>	89	75	50	18	75	18	89	50	50	89	18	75	18	50	75	89	<table border="1"><tr><td>89</td><td>75</td><td>50</td><td>18</td></tr><tr><td>75</td><td>18</td><td>89</td><td>50</td></tr><tr><td>50</td><td>89</td><td>18</td><td>75</td></tr><tr><td>18</td><td>50</td><td>75</td><td>89</td></tr></table>	89	75	50	18	75	18	89	50	50	89	18	75	18	50	75	89	<table border="1"><tr><td>89</td><td>75</td><td>50</td><td>18</td></tr><tr><td>75</td><td>18</td><td>89</td><td>50</td></tr><tr><td>50</td><td>89</td><td>18</td><td>75</td></tr><tr><td>18</td><td>50</td><td>75</td><td>89</td></tr></table>	89	75	50	18	75	18	89	50	50	89	18	75	18	50	75	89
89	75	50	18																																																																	
75	18	89	50																																																																	
50	89	18	75																																																																	
18	50	75	89																																																																	
89	75	50	18																																																																	
75	18	89	50																																																																	
50	89	18	75																																																																	
18	50	75	89																																																																	
89	75	50	18																																																																	
75	18	89	50																																																																	
50	89	18	75																																																																	
18	50	75	89																																																																	
89	75	50	18																																																																	
75	18	89	50																																																																	
50	89	18	75																																																																	
18	50	75	89																																																																	
P	<table border="1"><tr><td>1</td><td>0</td><td>0</td><td>0</td></tr><tr><td>0</td><td>1</td><td>0</td><td>0</td></tr><tr><td>0</td><td>0</td><td>0</td><td>1</td></tr><tr><td>0</td><td>0</td><td>1</td><td>0</td></tr></table>	1	0	0	0	0	1	0	0	0	0	0	1	0	0	1	0	<table border="1"><tr><td>0</td><td>1</td><td>0</td><td>0</td></tr><tr><td>0</td><td>0</td><td>0</td><td>1</td></tr><tr><td>0</td><td>0</td><td>1</td><td>0</td></tr><tr><td>1</td><td>0</td><td>0</td><td>0</td></tr></table>	0	1	0	0	0	0	0	1	0	0	1	0	1	0	0	0	<table border="1"><tr><td>0</td><td>0</td><td>0</td><td>1</td></tr><tr><td>0</td><td>0</td><td>1</td><td>0</td></tr><tr><td>1</td><td>0</td><td>0</td><td>0</td></tr><tr><td>0</td><td>1</td><td>0</td><td>0</td></tr></table>	0	0	0	1	0	0	1	0	1	0	0	0	0	1	0	0	<table border="1"><tr><td>0</td><td>0</td><td>1</td><td>0</td></tr><tr><td>1</td><td>0</td><td>0</td><td>0</td></tr><tr><td>0</td><td>1</td><td>0</td><td>0</td></tr><tr><td>0</td><td>0</td><td>0</td><td>1</td></tr></table>	0	0	1	0	1	0	0	0	0	1	0	0	0	0	0	1
1	0	0	0																																																																	
0	1	0	0																																																																	
0	0	0	1																																																																	
0	0	1	0																																																																	
0	1	0	0																																																																	
0	0	0	1																																																																	
0	0	1	0																																																																	
1	0	0	0																																																																	
0	0	0	1																																																																	
0	0	1	0																																																																	
1	0	0	0																																																																	
0	1	0	0																																																																	
0	0	1	0																																																																	
1	0	0	0																																																																	
0	1	0	0																																																																	
0	0	0	1																																																																	
PA	<table border="1"><tr><td>89</td><td>75</td><td>50</td><td>18</td></tr><tr><td>75</td><td>18</td><td>89</td><td>50</td></tr><tr><td>18</td><td>50</td><td>75</td><td>89</td></tr><tr><td>50</td><td>89</td><td>18</td><td>75</td></tr></table>	89	75	50	18	75	18	89	50	18	50	75	89	50	89	18	75	<table border="1"><tr><td>75</td><td>18</td><td>89</td><td>50</td></tr><tr><td>18</td><td>50</td><td>75</td><td>89</td></tr><tr><td>50</td><td>89</td><td>18</td><td>75</td></tr><tr><td>89</td><td>75</td><td>50</td><td>18</td></tr></table>	75	18	89	50	18	50	75	89	50	89	18	75	89	75	50	18	<table border="1"><tr><td>18</td><td>50</td><td>75</td><td>89</td></tr><tr><td>50</td><td>89</td><td>18</td><td>75</td></tr><tr><td>89</td><td>75</td><td>50</td><td>18</td></tr><tr><td>75</td><td>18</td><td>89</td><td>50</td></tr></table>	18	50	75	89	50	89	18	75	89	75	50	18	75	18	89	50	<table border="1"><tr><td>50</td><td>89</td><td>18</td><td>75</td></tr><tr><td>89</td><td>75</td><td>50</td><td>18</td></tr><tr><td>75</td><td>18</td><td>89</td><td>50</td></tr><tr><td>18</td><td>50</td><td>75</td><td>89</td></tr></table>	50	89	18	75	89	75	50	18	75	18	89	50	18	50	75	89
89	75	50	18																																																																	
75	18	89	50																																																																	
18	50	75	89																																																																	
50	89	18	75																																																																	
75	18	89	50																																																																	
18	50	75	89																																																																	
50	89	18	75																																																																	
89	75	50	18																																																																	
18	50	75	89																																																																	
50	89	18	75																																																																	
89	75	50	18																																																																	
75	18	89	50																																																																	
50	89	18	75																																																																	
89	75	50	18																																																																	
75	18	89	50																																																																	
18	50	75	89																																																																	
P^T	<table border="1"><tr><td>1</td><td>0</td><td>0</td><td>0</td></tr><tr><td>0</td><td>1</td><td>0</td><td>0</td></tr><tr><td>0</td><td>0</td><td>0</td><td>1</td></tr><tr><td>0</td><td>0</td><td>1</td><td>0</td></tr></table>	1	0	0	0	0	1	0	0	0	0	0	1	0	0	1	0	<table border="1"><tr><td>0</td><td>0</td><td>0</td><td>1</td></tr><tr><td>1</td><td>0</td><td>0</td><td>0</td></tr><tr><td>0</td><td>0</td><td>1</td><td>0</td></tr><tr><td>0</td><td>1</td><td>0</td><td>0</td></tr></table>	0	0	0	1	1	0	0	0	0	0	1	0	0	1	0	0	<table border="1"><tr><td>0</td><td>0</td><td>1</td><td>0</td></tr><tr><td>0</td><td>0</td><td>0</td><td>1</td></tr><tr><td>0</td><td>1</td><td>0</td><td>0</td></tr><tr><td>1</td><td>0</td><td>0</td><td>0</td></tr></table>	0	0	1	0	0	0	0	1	0	1	0	0	1	0	0	0	<table border="1"><tr><td>0</td><td>1</td><td>0</td><td>0</td></tr><tr><td>0</td><td>0</td><td>1</td><td>0</td></tr><tr><td>1</td><td>0</td><td>0</td><td>0</td></tr><tr><td>0</td><td>0</td><td>0</td><td>1</td></tr></table>	0	1	0	0	0	0	1	0	1	0	0	0	0	0	0	1
1	0	0	0																																																																	
0	1	0	0																																																																	
0	0	0	1																																																																	
0	0	1	0																																																																	
0	0	0	1																																																																	
1	0	0	0																																																																	
0	0	1	0																																																																	
0	1	0	0																																																																	
0	0	1	0																																																																	
0	0	0	1																																																																	
0	1	0	0																																																																	
1	0	0	0																																																																	
0	1	0	0																																																																	
0	0	1	0																																																																	
1	0	0	0																																																																	
0	0	0	1																																																																	
 C 	<table border="1"><tr><td>89</td><td>75</td><td>18</td><td>50</td></tr><tr><td>75</td><td>18</td><td>50</td><td>89</td></tr><tr><td>18</td><td>50</td><td>89</td><td>75</td></tr><tr><td>50</td><td>89</td><td>75</td><td>18</td></tr></table>	89	75	18	50	75	18	50	89	18	50	89	75	50	89	75	18	<table border="1"><tr><td>18</td><td>50</td><td>89</td><td>75</td></tr><tr><td>50</td><td>89</td><td>75</td><td>18</td></tr><tr><td>89</td><td>75</td><td>18</td><td>50</td></tr><tr><td>75</td><td>18</td><td>50</td><td>89</td></tr></table>	18	50	89	75	50	89	75	18	89	75	18	50	75	18	50	89	<table border="1"><tr><td>89</td><td>75</td><td>18</td><td>50</td></tr><tr><td>75</td><td>18</td><td>50</td><td>89</td></tr><tr><td>18</td><td>50</td><td>89</td><td>75</td></tr><tr><td>50</td><td>89</td><td>75</td><td>18</td></tr></table>	89	75	18	50	75	18	50	89	18	50	89	75	50	89	75	18	<table border="1"><tr><td>18</td><td>50</td><td>89</td><td>75</td></tr><tr><td>50</td><td>89</td><td>75</td><td>18</td></tr><tr><td>89</td><td>75</td><td>18</td><td>50</td></tr><tr><td>75</td><td>18</td><td>50</td><td>89</td></tr></table>	18	50	89	75	50	89	75	18	89	75	18	50	75	18	50	89
89	75	18	50																																																																	
75	18	50	89																																																																	
18	50	89	75																																																																	
50	89	75	18																																																																	
18	50	89	75																																																																	
50	89	75	18																																																																	
89	75	18	50																																																																	
75	18	50	89																																																																	
89	75	18	50																																																																	
75	18	50	89																																																																	
18	50	89	75																																																																	
50	89	75	18																																																																	
18	50	89	75																																																																	
50	89	75	18																																																																	
89	75	18	50																																																																	
75	18	50	89																																																																	
p	<table border="1"><tr><td>1</td><td>2</td><td>4</td><td>3</td></tr></table>	1	2	4	3	<table border="1"><tr><td>2</td><td>4</td><td>3</td><td>1</td></tr></table>	2	4	3	1	<table border="1"><tr><td>4</td><td>3</td><td>1</td><td>2</td></tr></table>	4	3	1	2	<table border="1"><tr><td>3</td><td>1</td><td>2</td><td>4</td></tr></table>	3	1	2	4																																																
1	2	4	3																																																																	
2	4	3	1																																																																	
4	3	1	2																																																																	
3	1	2	4																																																																	

This has a meaning that finding a specific base permutation matrix with $P_{1,1} = 1$, which is a solution, all cyclic permutations of the corresponding permutation vector are also solutions. Based on deduction the number of positive permutation vectors that arranges elements of $|A_n|$ into proper order are:

- $2 \times 4 = \mathbf{8}$ for $|A_4|$ out of $4! = 24$ possible permutation matrices
- $4 \times 8 = \mathbf{32}$ for $|A_8|$ out of $8! = 40320$ possible permutation matrices
- $8 \times 16 = \mathbf{128}$ for $|A_{16}|$ out of $16! \approx 2 \times 10^{13}$ possible permutation matrices

b) Signed base permutation vectors

Permuting an A_n odd DCT matrix with a positive permutation matrix according to $C = PAP^{-1}$ arranges elements of C in proper diagonal order but with wrong signed values (first column below). Changing signs in a particular P may lead to several correct results, as illustrated here with 4 signed base permutations found for $|\mathbf{p}| = (1, 2, 4, 3)$, out of $2^4 = 16$ possible variations:

A	$\begin{bmatrix} 89 & 75 & 50 & 18 \\ 75 & -18 & -89 & -50 \\ 50 & -89 & 18 & 75 \\ 18 & -50 & 75 & -89 \end{bmatrix}$	$\begin{bmatrix} 89 & 75 & 50 & 18 \\ 75 & -18 & -89 & -50 \\ 50 & -89 & 18 & 75 \\ 18 & -50 & 75 & -89 \end{bmatrix}$	$\begin{bmatrix} 89 & 75 & 50 & 18 \\ 75 & -18 & -89 & -50 \\ 50 & -89 & 18 & 75 \\ 18 & -50 & 75 & -89 \end{bmatrix}$	$\begin{bmatrix} 89 & 75 & 50 & 18 \\ 75 & -18 & -89 & -50 \\ 50 & -89 & 18 & 75 \\ 18 & -50 & 75 & -89 \end{bmatrix}$	$\begin{bmatrix} 89 & 75 & 50 & 18 \\ 75 & -18 & -89 & -50 \\ 50 & -89 & 18 & 75 \\ 18 & -50 & 75 & -89 \end{bmatrix}$
P	$\begin{bmatrix} 1 & 0 & 0 & 0 \\ 0 & 1 & 0 & 0 \\ 0 & 0 & 0 & 1 \\ 0 & 0 & 1 & 0 \end{bmatrix}$	$\begin{bmatrix} 1 & 0 & 0 & 0 \\ 0 & 1 & 0 & 0 \\ 0 & 0 & 0 & -1 \\ 0 & 0 & 1 & 0 \end{bmatrix}$	$\begin{bmatrix} 1 & 0 & 0 & 0 \\ 0 & -1 & 0 & 0 \\ 0 & 0 & 0 & -1 \\ 0 & 0 & -1 & 0 \end{bmatrix}$	$\begin{bmatrix} -1 & 0 & 0 & 0 \\ 0 & -1 & 0 & 0 \\ 0 & 0 & 0 & 1 \\ 0 & 0 & -1 & 0 \end{bmatrix}$	$\begin{bmatrix} -1 & 0 & 0 & 0 \\ 0 & 1 & 0 & 0 \\ 0 & 0 & 0 & 1 \\ 0 & 0 & 1 & 0 \end{bmatrix}$
PA	$\begin{bmatrix} 89 & 75 & 50 & 18 \\ 75 & -18 & -89 & -50 \\ 18 & -50 & 75 & -89 \\ 50 & -89 & 18 & 75 \end{bmatrix}$	$\begin{bmatrix} 89 & 75 & 50 & 18 \\ 75 & -18 & -89 & -50 \\ -18 & 50 & -75 & 89 \\ 50 & -89 & 18 & 75 \end{bmatrix}$	$\begin{bmatrix} 89 & 75 & 50 & 18 \\ -75 & 18 & 89 & 50 \\ -18 & 50 & -75 & 89 \\ -50 & 89 & -18 & -75 \end{bmatrix}$	$\begin{bmatrix} -89 & -75 & -50 & -18 \\ -75 & 18 & 89 & 50 \\ 18 & -50 & 75 & -89 \\ -50 & 89 & -18 & -75 \end{bmatrix}$	$\begin{bmatrix} -89 & -75 & -50 & -18 \\ 75 & -18 & -89 & -50 \\ 18 & -50 & 75 & -89 \\ 50 & -89 & 18 & 75 \end{bmatrix}$
P^T	$\begin{bmatrix} 1 & 0 & 0 & 0 \\ 0 & 1 & 0 & 0 \\ 0 & 0 & 0 & 1 \\ 0 & 0 & 1 & 0 \end{bmatrix}$	$\begin{bmatrix} 1 & 0 & 0 & 0 \\ 0 & 1 & 0 & 0 \\ 0 & 0 & 0 & 1 \\ 0 & 0 & -1 & 0 \end{bmatrix}$	$\begin{bmatrix} 1 & 0 & 0 & 0 \\ 0 & -1 & 0 & 0 \\ 0 & 0 & 0 & -1 \\ 0 & 0 & -1 & 0 \end{bmatrix}$	$\begin{bmatrix} -1 & 0 & 0 & 0 \\ 0 & -1 & 0 & 0 \\ 0 & 0 & 0 & -1 \\ 0 & 0 & 1 & 0 \end{bmatrix}$	$\begin{bmatrix} -1 & 0 & 0 & 0 \\ 0 & 1 & 0 & 0 \\ 0 & 0 & 0 & 1 \\ 0 & 0 & 1 & 0 \end{bmatrix}$
C	$\begin{bmatrix} 89 & 75 & 18 & 50 \\ 75 & -18 & -50 & -89 \\ 18 & -50 & -89 & 75 \\ 50 & -89 & 75 & 18 \end{bmatrix}$	$\begin{bmatrix} 89 & 75 & -18 & 50 \\ 75 & -18 & 50 & -89 \\ -18 & 50 & -89 & -75 \\ 50 & -89 & -75 & 18 \end{bmatrix}$	$\begin{bmatrix} 89 & -75 & -18 & -50 \\ -75 & -18 & -50 & -89 \\ -18 & -50 & -89 & 75 \\ -50 & -89 & 75 & 18 \end{bmatrix}$	$\begin{bmatrix} 89 & 75 & -18 & 50 \\ 75 & -18 & 50 & -89 \\ -18 & 50 & -89 & -75 \\ 50 & -89 & -75 & 18 \end{bmatrix}$	$\begin{bmatrix} 89 & -75 & -18 & -50 \\ -75 & -18 & -50 & -89 \\ -18 & -50 & -89 & 75 \\ -50 & -89 & 75 & 18 \end{bmatrix}$
p	$\begin{bmatrix} 1 & 2 & 4 & 3 \end{bmatrix}$	$\begin{bmatrix} 1 & 2 & -4 & 3 \end{bmatrix}$	$\begin{bmatrix} 1 & -2 & -4 & -3 \end{bmatrix}$	$\begin{bmatrix} -1 & -2 & 4 & -3 \end{bmatrix}$	$\begin{bmatrix} -1 & 2 & 4 & 3 \end{bmatrix}$

There is a sign-symmetry among the solutions. Applying a specific P and $-P$ results in the same C matrix, meaning solutions for a signed p permutation vector come in pairs that are negatives of each other. The following table has been generated programmatically by verifying all 2^n possible signed combinations, whether $C=PA P^{-1}$ becomes anti-circulant, for each of the positive base vector $|p_n|$ from the previous table. Note that there were always 2 signed solutions per positive base vector found, regardless of n :

$p_{n=4}$	$p_{n=8}$	$p_{n=16}$
$\begin{bmatrix} 1 & 2 & -4 & 3 \\ 1 & -2 & -4 & -3 \\ 1 & 3 & 4 & 2 \\ 1 & -3 & 4 & -2 \end{bmatrix}$	$\begin{bmatrix} 1 & 2 & 5 & -3 & -8 & 7 & -4 & 6 \\ 1 & -2 & 5 & 3 & -8 & -7 & -4 & -6 \\ 1 & 3 & -4 & 2 & 8 & 6 & 5 & -7 \\ 1 & -3 & -4 & -2 & 8 & -6 & 5 & 7 \\ 1 & 6 & 4 & 7 & 8 & -3 & -5 & 2 \\ 1 & -6 & 4 & -7 & 8 & 3 & -5 & -2 \\ 1 & 7 & -5 & -6 & -8 & -2 & 4 & -3 \\ 1 & -7 & -5 & 6 & -8 & 2 & 4 & 3 \end{bmatrix}$	$\begin{bmatrix} 1 & 2 & 5 & 14 & -9 & 7 & -13 & 6 & -16 & 15 & -12 & 3 & 8 & -10 & 4 & 11 \\ 1 & -2 & 5 & -14 & -9 & -7 & -13 & -6 & -16 & -15 & -12 & -3 & 8 & 10 & 4 & -11 \\ 1 & 3 & 13 & 2 & 8 & -6 & 5 & -10 & 16 & 14 & 4 & -15 & -9 & 11 & 12 & 7 \\ 1 & -3 & 13 & -2 & 8 & 6 & 5 & 10 & 16 & -14 & 4 & 15 & -9 & -11 & 12 & -7 \\ 1 & 6 & 4 & -7 & -8 & 14 & -12 & -2 & 16 & -11 & -13 & -10 & 9 & -3 & 5 & 15 \\ 1 & -6 & 4 & 7 & -8 & -14 & -12 & 2 & 16 & 11 & -13 & 10 & 9 & 3 & 5 & -15 \\ 1 & 7 & -12 & 11 & 9 & -15 & -4 & 14 & -16 & -10 & -5 & -6 & -8 & 2 & -13 & 3 \\ 1 & -7 & -12 & -11 & 9 & 15 & -4 & -14 & -16 & 10 & -5 & 6 & -8 & -2 & -13 & -3 \\ 1 & 10 & 12 & -6 & 9 & -2 & 4 & 3 & -16 & 7 & 5 & -11 & -8 & -15 & 13 & -14 \\ 1 & -10 & 12 & 6 & 9 & 2 & 4 & -3 & -16 & -7 & 5 & 11 & -8 & 15 & 13 & 14 \\ 1 & 11 & -4 & -10 & -8 & 3 & 12 & 15 & 16 & 6 & 13 & 7 & 9 & 14 & -5 & 2 \\ 1 & -11 & -4 & 10 & -8 & -3 & 12 & -15 & 16 & -6 & 13 & -7 & 9 & -14 & -5 & -2 \\ 1 & 14 & -13 & 15 & 8 & 11 & -5 & -7 & 16 & -3 & -4 & 2 & -9 & 6 & -12 & -10 \\ 1 & -14 & -13 & -15 & 8 & -11 & -5 & 7 & 16 & 3 & -4 & -2 & -9 & -6 & -12 & 10 \\ 1 & 15 & -5 & -3 & -9 & -10 & 13 & -11 & -16 & -2 & 12 & 14 & 8 & -7 & -4 & 6 \\ 1 & -15 & -5 & 3 & -9 & 10 & 13 & 11 & -16 & 2 & 12 & -14 & 8 & 7 & -4 & -6 \end{bmatrix}$

Any of these signed permutation vectors together with their negated pair are solutions for the final algorithm.

Cyclic permutations of the signed permutation vector

As for cycling rows of positive P , there is a similar rule when cycling a signed P permutation matrix. To keep $C=PA P^{-1}$ signed anti-circulant, the bottom row of P has to be negated, which is equivalent to

cycling p left then negating the last element (“sign-cycling”). An interesting correlation to how a sign-anti-circulant matrix is defined the same way, sign-cycling its columns.

For example sign-cycling $p = (1, 2, -4, 3)$ there are 8 different permutations. These appear as 4 negated pairs, where again, applying the negated vector results in the same C matrix:

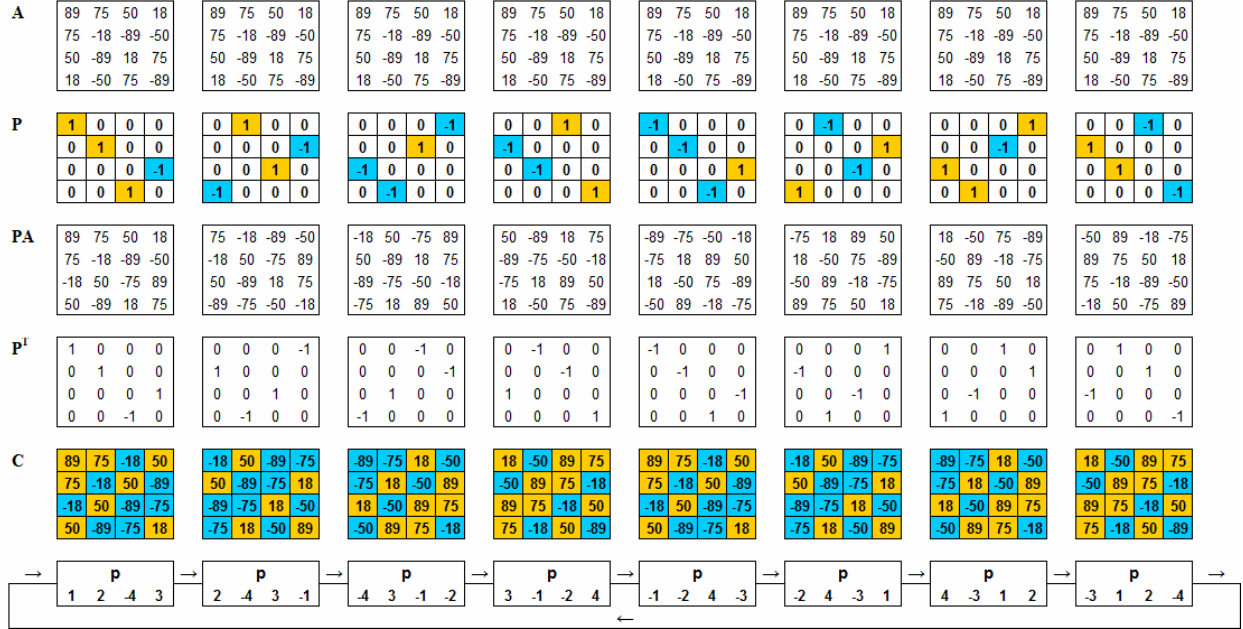

Investigating other and also higher order permutation vectors we can deduce the following symmetry rule for the result of $C = PAP^T$ based on sign-cycling a specific order- N permutation vector $2 \times N$ -times:

No. of sign-cyclic permutations of p_n			
$\times 2N$			
$\times N$		$\times N$	
corresponding $p_{0..n}$		corresponding $-p_{0..n}$	
$\times N/2$	$\times N/2$	$\times N/2$	$\times N/2$
$C_{0..n/2}$	$-C_{0..n/2}$	$C_{0..n/2}$	$-C_{0..n/2}$

This finding has the importance for computing the integer multipliers for the circulant solver algorithm as the C_n matrix and all its sub-matrix products (D , U and V) will be different. There is enough to list and investigate constants for only $N/2$ sign-cyclic permutations of an order- N signed permutation vector.

For example generating the final 9 multipliers for all 8 sign-cyclic permutations of $p = (1, 2, -4, 3)$, for $N=4$ we get:

1	2	-4	3	82	25	46	-68	50	-139	54	-125	232	C_0
2	-4	3	-1	-54	125	-232	-14	-75	93	82	25	46	C_1
-4	3	-1	-2	-82	-25	-46	68	-50	139	-54	125	-232	$-C_0$
3	-1	-2	4	54	-125	232	14	75	-93	-82	-25	-46	$-C_1$
-1	-2	4	-3	82	25	46	-68	50	-139	54	-125	232	C_0
-2	4	-3	1	-54	125	-232	-14	-75	93	82	25	46	C_1
4	-3	1	2	-82	-25	-46	68	-50	139	-54	125	-232	$-C_0$
-3	1	2	-4	54	-125	232	14	75	-93	-82	-25	-46	$-C_1$

A compiled list of all multiplier constants for the order-4, -8 and -16 can be found in the Appendix for $N/2$ sign-cycled permutations each.

Summary of results

Now we can answer the original question in the beginning of Part II. Yes, there exist numerous signed permutation matrices that transforms the A_n odd-DCT matrix of any order- N to some circulant form by applying $C=PAP^{-1}$.

There were different numbers of positive base permutations for a particular n that arrange $|A_n|$ to anti-circulant form. From $n!$ possibilities these were derived manually by the spreadsheet method. For A_n , every positive base permutation has 2 signed base permutations, and every signed base permutation has $2 \times n$ signed-cyclic variations, which arrange A_n to the desired signed-anti-circulant form.

Multiplying C by a column vector requires $3^{\log_2 n}$ multiplications instead of n^2 based on the circulant solver algorithm. Follows a comparison of the first ten $n \times n$ such anti-circulant matrices and the number of required multiplications to solve the matrix-vector product with the naïve and recursive circulant multiplication method:

$\log_2 n$	1	2	3	4	5	6	7	8	9	10
n	2	4	8	16	32	64	128	256	512	1024
Naïve: n^2	4	16	64	256	1024	4096	16384	65536	262144	1048576
Circulant: $3^{\log_2 n}$	3	9	27	81	243	729	2187	6561	19683	59049
Decrease:	25 %	44 %	58 %	68 %	76 %	82 %	87 %	90 %	92 %	94 %

Which signed permutation vector is chosen for the final algorithm may have impact on the generated code. For permuting the input vector, one can prefer the least number of negations to run the code slightly faster. Below are a permutation with the least number of negations for each A_n :

1. $\mathbf{p}_4 = (1, 3, 4, 2)$ with zero for A_4
2. $\mathbf{p}_8 = (8, 7, 4, 6, 1, -2, 5, 3)$ with one for A_8
3. $\mathbf{p}_{16} = (3, 12, 15, 16, 6, 13, 7, 9, 14, -5, 2, -1, -11, 4, 10, 8)$ with three for A_{16}

Another consideration is the different multipliers used. Each permutation results in different U , D and V sub-matrices used to compute the constant multipliers. From the $2 \times N$ signed-cyclic variations $N/2$ will result in different multiplier constant sets. Multiplication-free implementations can chose a specific set, which is the best candidate for dyadic decomposition. Appendix includes the full compiled list of multipliers for each A_n odd DCT matrices.

The final algorithm

Based on the results in Part II now all four $A_n \times$ product can be solved with fewer multiplications by using the equation $P^T C P x$. For implementing the final algorithm, 3 signed permutation vectors were picked from the list, corresponding to P_4 , P_8 and P_{16} :

- $\mathbf{p}_4 = (1, 3, 4, 2)$
 $\mathbf{p}_8 = (8, 7, 4, 6, 1, -2, 5, 3)$
 $\mathbf{p}_{16} = (3, 12, 15, 16, 6, 13, 7, 9, 14, -5, 2, -1, -11, 4, 10, 8)$

Furthermore, P can be incorporated into the input vector mapping and P^T into the corresponding B_n matrices at no additional computational cost, making the algorithm even faster. For the *input mapping*, multiplying P_n with the corresponding $x_{n\text{-odd}}$ lists we get:

$$m_4 = (x_{4\text{even}}, x_{4\text{odd}}) = (0, 2, 1, 3),$$

$$m_8 = (2m_4, \mathbf{P}_4 x_{8\text{odd}}),$$

$$m_{16} = (2m_8, \mathbf{P}_8 x_{16\text{odd}}),$$

$$m_{32} = (2m_{16}, \mathbf{P}_{16} x_{32\text{odd}})$$

For the *output*, multiplying the left part of each B_n with $P_{n/2}^T$ we get:

$$B'_n = \begin{bmatrix} I_{n/2} & I_{n/2} P_{n/2}^T \\ I_{n/2}^r & -I_{n/2}^r P_{n/2}^T \end{bmatrix}$$

For illustration, the data flow of Part I has been modified. A_4 , A_8 and A_{16} are now the signed anti-circulant C_4 , C_8 and C_{16} matrices (B_4 remains the same, A_2 is already *circulant*). The 3 permutation matrices of P_4 , P_8 and P_{16} have been incorporated into the input vector mapping and P^T into the corresponding B_8 , B_{16} and B_{32} matrices:

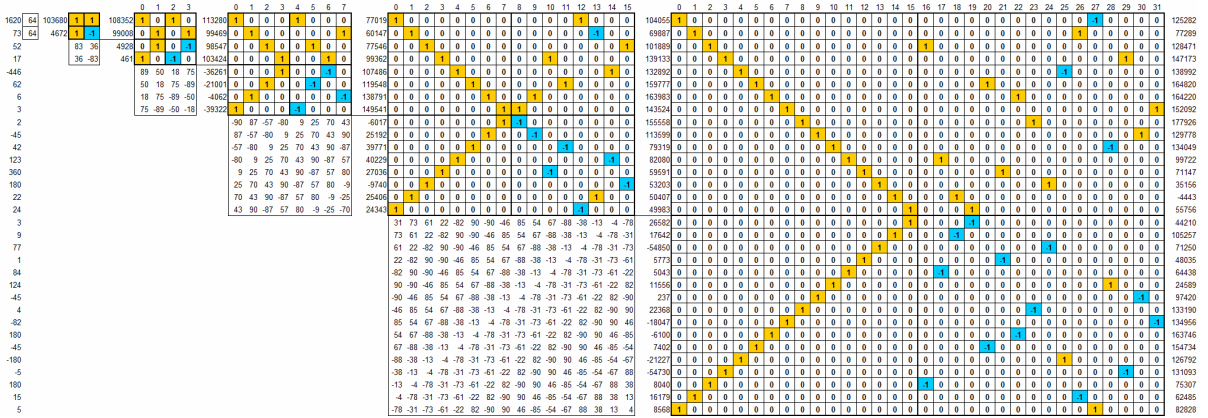

This algorithm solves the HEVC N-point 1-D integer transform with the following number of multiplications:

- 4-point: 2-point (shift left – zero multiplication) + 3 multiplications for $A_2=C_2$: **3**
- 8-point: 4-point + 9 multiplications for C_4 : **12**
- 16-point: 8-point + 27 multiplications for C_8 : **39**
- 32-point: 16-point + 81 multiplications for C_{16} : **120**

The forward integer transform

It is worth mentioning that the forward integer transform can also be computed according to the final algorithm as a series of matrix-vector multiplications of $A_n x$ and $B_n x$ with the following modifications. The data flow is inverted: it starts with a series of additions/subtractions of the input column vector. Reflecting the transposed integer DCT matrix, symmetries appear for rows instead of columns; therefore the B_n matrices are also transposed with a common structure of

The circulant solver for the matrix-vector multiplication of Cx .

```
circulant_solver(C, X, N)
{
    if (N==1) multiply
    else
    {
        diag = circulant_solver(D, X0+X1, N/2)
        upper = circulant_solver(U, X0, N/2)
        lower = circulant_solver(L, X1, N/2)
        Y0 = diag + upper
        Y1 = diag + lower
    }
}
```

For the circulant solver the goal was to serialize this recursive adder/multiplier algorithm with a set of integer constants. Another challenge was to avoid of using temporarily variables. For a complete implementation based on 3 example signed permutation vectors see `transform.c`. These vectors were chosen with the most number of multipliers that can be implemented as shifts.

Performance measurements

A simple measurement has been made against an un-optimized, naïve matrix multiplication routine using MS VS2005, compared to an optimization disabled and optimized for speed (/O2) version of `transform.c`. Seven measurements have been performed and the averages of the results are presented in the table.

	Iterated x times	Naïve	Opt disabled		Optimized for speed	
		Duration (seconds)	Duration (seconds)	Speed increase	Duration (seconds)	Speed increase
32-point	5 million	18.56	2.51	7.39	0.77	23.98
16-point	20 million	19.77	3.52	5.61	1.20	16.45
8-point	50 million	12.50	3.18	3.93	1.14	10.96
4-point	160 million	12.10	3.67	3.29	0.94	12.85

AMD Phenom™ II X4 965 @ 3.40 GHz, 64-bit Windows™ 7.

Appendix: The circulant solver algorithm

A signed anti-circulant matrix is also recursively circulant, as illustrated by the sum-s of values of lower order matrices below with the following 8x8 matrix (C_0):

90	80	-70	87	9	43	57	-25
80	-70	87	9	43	57	-25	-90
-70	87	9	43	57	-25	-90	-80
87	9	43	57	-25	-90	-80	70
9	43	57	-25	-90	-80	70	-87
43	57	-25	-90	-80	70	-87	-9
57	-25	-90	-80	70	-87	-9	-43
-25	-90	-80	70	-87	-9	-43	-57

C_0

180	113	152	-83
113	152	-83	-180
152	-83	-180	-113
-83	-180	-113	-152

C_1

558	-194
-194	-558

C_2

The C_0 -vector multiplication can be solved adding 3 sub-matrix-vector products starting from C_2 . Each sub-matrix is again anti-circulant and can be solved from 3 lower sub-matrix-vector products, 3^2 for C_1 . The next level is C_0 , the scalar case, where the 3^3 multiplications occur.

For $\begin{bmatrix} Y_0 \\ Y_1 \end{bmatrix} = \begin{bmatrix} U & D \\ D & V \end{bmatrix} \begin{bmatrix} X_0 \\ X_1 \end{bmatrix} = \begin{bmatrix} UX_0 + DX_1 \\ DX_0 + VX_1 \end{bmatrix}$ using 4 multiplications (matrix- or scalar) we can construct the basic building block using 3 multiplications:

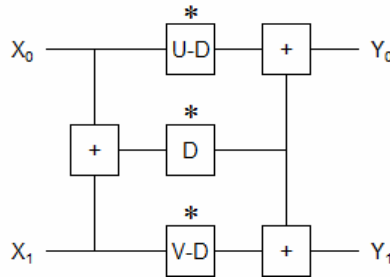

All the multiplications with this algorithm can be performed parallel without latency and are independent of each other. From 3 scalar building blocks with additional adds the 4-point solver may look like this, which uses 9 multipliers:

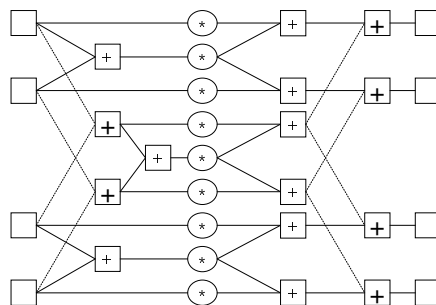

For example p_4 has 4 signed base permutation vectors that transforms A_4 to a circulant C_4 . The following table lists $N/2=2$ cyclic permutations of each p_4 :

p_4				K_i									
1	2	-4	3	82	25	46	-68	50	-139	54	-125	232	
2	-4	3	-1	-54	125	-232	-14	-75	93	82	25	46	
3	3	-1	2	54	-125	232	14	75	-93	-82	-25	-46	
4	-1	2	-4	-132	32	-96	32	-50	-39	-196	125	-18	

DRAFT-v1

-2	-4	-3	-1		196	-125	18	-164	75	-57	132	-25	96
1	3	4	2		96	-25	132	-57	75	-164	18	-125	196
3	4	2	-1		-18	125	-196	-39	-50	32	96	-25	132
1	-3	4	-2		46	25	82	93	-75	-14	-232	125	-54
-3	4	-2	-1		232	-125	54	-139	50	-68	46	25	82

The 4-point solver can be *loaded* with any of these constant sets. To improve performance choosing multipliers with least possible terms of dyadic composition can be an advantage. For example:

- $132 = 128 + 4 \rightarrow (x \ll 7) + (x \ll 2)$
- $96 = 64 + 16 \rightarrow (x \ll 6) + (x \ll 4)$
- $68 = 64 + 4 \rightarrow (x \ll 6) + (x \ll 2)$
- $14 = 16 - 2 \rightarrow (x \ll 4) - (x \ll 1)$
- $18 = 16 + 2 \rightarrow (x \ll 4) + (x \ll 1)$
- $7 = 8 - 1 \rightarrow (x \ll 3) - x$
- $112 = 128 - 16 \rightarrow (x \ll 7) - (x \ll 4)$

Similarly, from 3×4 -point solver blocks with additional adds the 8-point solver may look like this, which uses 27 multipliers:

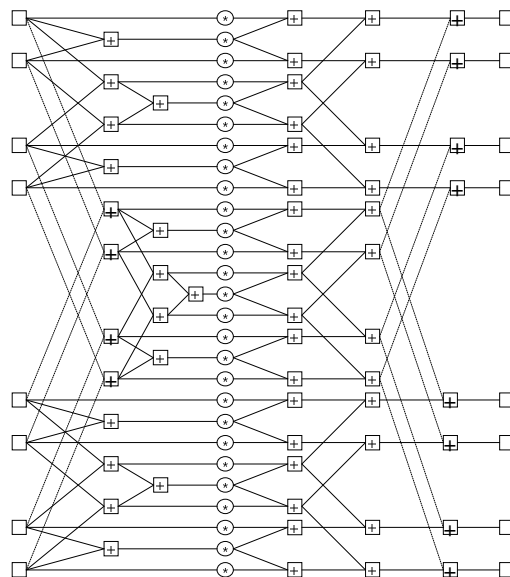

The following table lists the computed 27 multiplier constants according to the first $8/2=4$ sign-cyclic combinations of all 8 signed base permutation p_8 vectors:

1	2	5	-3	-8	7	-4	6		-213	185	-139	250	-123	204	-281	235	-329	79	-18	38	-113				
									43	-133	110	-130	163	55	-149	63	-24	37	62	61	25	3			
2	5	-3	-8	7	-4	6	-1		281	-235	329	-31	112	-125	55	-149	63	-110	130	-163	-3	-87			
									30	-134	167	-101	-61	-25	-3	37	62	65	213	-185	139				
5	-3	-8	7	-4	6	-1	-2		-55	149	-63	24	-37	-62	-61	-25	-3	134	-167	101	-137	80	-71		
									171	-105	166	-213	185	-139	250	-123	204	-281	235	-329					
-3	-8	7	-4	6	-1	-2	-5		61	25	3	-37	-62	-65	-213	185	-139	-171	105	-166	34	-25	95		
									79	-18	38	281	-235	329	-31	112	-125	55	-149	63					
1	-2	5	3	-8	-7	-4	-6		157	-185	231	4	123	-42	189	-235	141	43	18	2	-27	-43	-47	-150	
									130	-97	-243	149	-235	50	-37	136	111	-25	53						
-2	5	3	-8	-7	-4	-6	-1		-189	235	-141	193	-112	99	-243	149	-235	150	-130	97	-177				
									87	-144	200	-167	233	-111	25	-53	161	-62	189	-157	185	-231			

DRAFT-v1

5	3	-8	-7	-4	-6	-1	2		243 -149 235 -50 37 -136 -111 25 -53 -200 167 -233 23 -80 89 -39 105 -44 157 -185 231 4 123 -42 189 -235 141
3	-8	-7	-4	-6	-1	2	-5		111 -25 53 -161 62 -189 157 -185 231 39 -105 44 -16 25 45 43 18 2 -189 235 -141 193 -112 99 -243 149 -235
1	3	-4	2	8	6	5	-7		283 -75 -151 -239 112 -13 215 11 -123 -116 68 79 82 -25 -65 -92 -55 215 -51 -61 -7 75 -62 143 -31 99 -307
3	-4	2	8	6	5	-7	-1		-215 -11 123 -24 123 -136 -51 -61 -7 92 55 -215 -10 -80 150 167 -7 -72 31 -99 307 44 37 -164 -283 75 151
-4	2	8	6	5	-7	-1	-3		51 61 7 -75 62 -143 31 -99 307 -167 7 72 157 -87 78 -123 44 -92 283 -75 -151 -239 112 -13 215 11 -123
2	8	6	5	-7	-1	-3	4		-31 99 -307 -44 -37 164 283 -75 -151 123 -44 92 34 -43 -14 -116 68 79 -215 -11 123 -24 123 -136 -51 -61 -7
1	-3	-4	-2	8	-6	5	7		133 75 -301 -15 -112 211 237 -11 -101 20 -68 215 32 25 -115 -202 55 105 -173 61 -129 -49 62 19 167 -99 -109
-3	-4	-2	8	-6	5	7	-1		-237 11 101 222 -123 110 -173 61 -129 202 -55 -105 -170 80 -10 153 7 -86 -167 99 109 118 -37 -90 -133 -75 301
-4	-2	8	-6	5	7	-1	3		173 -61 129 49 -62 -19 -167 99 109 -153 -7 86 -17 87 -96 -35 -44 -4 133 75 -301 -15 -112 211 237 -11 -101
-2	8	-6	5	7	-1	3	4		167 -99 -109 -118 37 90 133 75 -301 35 44 4 -52 43 -100 20 -68 215 -237 11 101 222 -123 110 -173 61 -129
1	6	4	7	8	-3	-5	2		-231 185 -157 189 -62 161 -53 25 -111 233 -167 200 -144 87 -177 97 -130 150 -235 149 -243 99 -112 193 -141 235 -189
6	4	7	8	-3	-5	2	-1		53 -25 111 136 -37 50 -235 149 -243 -97 130 -150 -47 -43 -27 2 18 43 141 -235 189 -42 123 4 231 -185 157
4	7	8	-3	-5	2	-1	-6		235 -149 243 -99 112 -193 141 -235 189 -2 -18 -43 -45 -25 16 -44 105 -39 -231 185 -157 189 -62 161 -53 25 -111
7	8	-3	-5	2	-1	-6	-4		-141 235 -189 42 -123 -4 -231 185 -157 44 -105 39 -89 80 -23 233 -167 200 53 -25 111 136 -37 50 -235 149 -243
1	-6	4	-7	8	3	-5	-2		139 -185 213 65 62 37 -3 -25 -61 -101 167 -134 30 -87 -3 -163 130 -110 63 -149 55 -125 112 -31 329 -235 281
-6	4	-7	8	3	-5	-2	-1		3 25 61 62 37 -24 63 -149 55 163 -130 110 -133 43 -113 38 -18 79 -329 235 -281 204 -123 250 -139 185 -213
4	-7	8	3	-5	-2	-1	6		-63 149 -55 125 -112 31 -329 235 -281 -38 18 -79 -95 25 -34 166 -105 171 139 -185 213 65 62 37 -3 -25 -61
-7	8	3	-5	-2	-1	6	-4		329 -235 281 -204 123 -250 139 -185 213 -166 105 -171 71 -80 137 -101 167 -134 3 25 61 62 37 -24 63 -149 55
1	7	-5	-6	-8	-2	4	-3		151 75 -283 -164 37 44 307 -99 31 -72 -7 167 150 -80 -10 -215 55 92 -7 -61 -51 -136 123 -24 123 -11 -215
7	-5	-6	-8	-2	4	-3	-1		-307 99 -31 143 -62 75 -7 -61 -51 215 -55 -92 -65 -25 82 79 68 -116 -123 11 215 -13 112 -239 -151 -75 283
-5	-6	-8	-2	4	-3	-1	-7		7 61 51 136 -123 24 -123 11 215 -79 -68 116 14 43 -34 -92 44 -123 151 75 -283 -164 37 44 307 -99 31
-6	-8	-2	4	-3	-1	-7	5		123 -11 -215 13 -112 239 151 75 -283 92 -44 123 -78 87 -157 -72 -7 167 -307 99 -31 143 -62 75 -7 -61 -51
1	-7	-5	6	-8	2	4	3		301 -75 -133 -90 -37 118 109 99 -167 -86 7 153 -10 80 -170 -105 -55 202 -129 61 -173 110 -123 222 101 11 -237
-7	-5	6	-8	2	4	3	-1		-109 -99 167 19 62 -49 -129 61 -173 105 55 -202 -115 25 32 215 -68 20 -101 -11 237 211 -112 -15 -301 75 133
-5	6	-8	2	4	3	-1	7		129 -61 173 -110 123 -222 -101 -11 237 -215 68 -20 100 -43 52 -4 -44 -35 301 -75 -133 -90 -37 118 109 99 -167
6	-8	2	4	3	-1	7	5		101 11 -237 -211 112 15 301 -75 -133 4 44 35 96 -87 17 -86 7 153 -109 -99 167 19 62 -49 -129 61 -173

The 16-point solver uses 81 multipliers and consists of 3 x 8-point solver blocks with additional adders. Not drawn. The table lists the computed 81 multiplier constants according to the first 16/2=8 sign-cyclic combinations of all 16 signed base permutation p_{16} vectors. Some attention is drawn to certain multiplier sets, where zero, 4, 8, 32 or other dyadic values occur and can be implemented as shift:

1 2 5 14 -9 7 -13 6 -16 15 -12 3 8 -10 4 11	-62 48 402 334 -98 -116 -572 122 -68 -107 95 -297 -148 32 54 131 71 -113 156 -102 342 82 78 -158 -78 -162 252 27 25 -305 -165 42 115 286 -6 16 82 -100 275 39 46 -136 -39 -136 144 -22 32 -350 -99 -68 219 233 85 -123 8 -98 208 -4 14 -114 0 -110 36 -57 105 -253 70 -124 218 -53 201 -175 -112 38 358 116 58 -280 -388 -8 -6
2 5 14 -9 7 -13 6 -16 15 -12 3 8 -10 4 11 -1	572 -122 68 -238 24 -184 156 -102 342 -131 -71 113 -17 103 -59 -49 7 -45 78 162 -252 4 -84 94 -8 98 -208 -286 6 -16 121 36 131 -22 32 -350 39 136 -144 0 -90 8 -60 68 75 -233 -85 123 134 17 96 35 -73 -97 0 110 -36 -4 -96 -78 -112 38 358 53 -201 175 17 77 43 169 -143 -105 388 8 6 -272 50 -286 -62 48 402

DRAFT-v1

5 14 -9 7 -13 6 -16 15 -12 3 8 -10 4 11 -1 -2	-156 102 -342 -82 -78 158 78 162 -252 49 -7 45 -66 110 -104 53 -91 139 8 -98 208 -4 14 -114 0 -110 36 22 -32 350 99 68 -219 -233 -85 123 60 -68 -75 -60 -22 83 194 -51 21 -35 73 97 169 -56 -1 -286 116 -52 112 -38 -358 -116 -58 280 388 8 6 -169 143 105 186 -66 -62 -441 193 -181 62 -48 -402 -334 98 116 572 -122 68
14 -9 7 -13 6 -16 15 -12 3 8 -10 4 11 -1 -2 -5	-78 -162 252 -4 84 -94 8 -98 208 -53 91 -139 -13 19 35 -57 105 -253 0 110 -36 -4 -96 -78 -112 38 358 233 85 -123 -134 -17 -96 -35 73 97 -194 51 -21 134 -73 104 -25 -5 -22 286 -116 52 -117 60 -53 134 -70 -8 -388 -8 -6 272 -50 286 62 -48 -402 441 -193 181 -255 127 -243 107 -95 297 -572 122 -68 238 -24 184 -156 102 -342
-9 7 -13 6 -16 15 -12 3 8 -10 4 11 -1 -2 -5 -14	-8 98 -208 4 -14 114 0 110 -36 57 -105 253 -70 124 -218 53 -201 175 112 -38 -358 -116 -58 280 388 8 6 35 -73 -97 -169 56 1 286 -116 52 25 5 22 109 -78 82 -92 65 -31 -134 70 8 17 -10 -61 -155 77 -129 -62 48 402 334 -98 -116 -572 122 -68 -107 95 -297 -148 32 54 131 71 -113 156 -102 342 82 78 -158 -78 -162 252
7 -13 6 -16 15 -12 3 8 -10 4 11 -1 -2 -5 -14 9	0 -110 36 4 96 78 112 -38 -358 -53 201 -175 -17 -77 -43 -169 143 105 -388 -8 -6 272 -50 286 62 -48 -402 -286 116 -52 117 -60 53 -134 70 8 92 -65 31 17 -13 51 109 -75 -30 155 -77 129 -138 67 -190 -27 -25 305 572 -122 68 -238 24 -184 156 -102 342 -131 -71 113 -17 103 -59 -49 7 -45 78 162 -252 4 -84 94 -8 98 -208
-13 6 -16 15 -12 3 8 -10 4 11 -1 -2 -5 -14 9 -7	-112 38 358 116 58 -280 -388 -8 -6 169 -143 -105 -186 66 62 441 -193 181 -62 48 402 334 -98 -116 -572 122 -68 134 -70 -8 -17 10 61 155 -77 129 -109 75 30 126 -88 21 -247 142 -160 27 25 -305 -165 42 115 286 -6 16 -156 102 -342 -82 -78 158 78 162 -252 49 -7 45 -66 110 -104 53 -91 139 8 -98 208 -4 14 -114 0 -110 36
6 -16 15 -12 3 8 -10 4 11 -1 -2 -5 -14 9 -7 13	388 8 6 -272 50 -286 -62 48 402 -441 193 -181 255 -127 243 -107 95 -297 572 -122 68 -238 24 -184 156 -102 342 -155 77 -129 138 -67 190 27 25 -305 247 -142 160 -121 54 -139 82 -100 275 -286 6 -16 121 36 131 -22 32 -350 -78 -162 252 -4 84 -94 8 -98 208 -53 91 -139 -13 19 35 -57 105 -253 0 110 -36 -4 -96 -78 -112 38 358
1 -2 5 -14 -9 -7 -13 -6 -16 -15 -12 -3 8 10 4 -11	34 -48 498 138 98 -312 -328 -122 176 83 -95 -107 -84 -32 118 273 -71 29 -48 102 138 238 -78 -2 -402 162 -72 77 -25 -255 -81 -42 199 274 6 4 -118 100 75 131 -46 -44 -311 136 -128 42 -32 -286 -235 68 83 403 -85 47 -188 98 12 24 -14 -86 -220 110 -184 153 -105 -43 -178 124 -30 349 -201 227 -36 -38 434 232 -58 -164 -404 8 -22
-2 5 -14 -9 -7 -13 -6 -16 -15 -12 -3 8 10 4 -11 -1	328 122 -176 -190 -24 -136 -48 102 138 -273 71 -29 189 -103 147 -35 -7 -31 402 -162 72 -164 84 -74 188 -98 -12 -274 -6 -4 193 -36 203 42 -32 -286 311 -136 128 -180 90 -172 76 -68 211 -403 85 -47 168 -17 130 -111 73 -243 220 -110 184 -196 96 -270 -36 -38 434 -349 201 -227 171 -77 197 -117 143 -391 404 -8 22 -172 -50 -186 34
5 -14 -9 -7 -13 -6 -16 -15 -12 -3 8 10 4 -11 -1 2	48 -102 -138 -238 78 2 402 -162 72 35 7 31 154 -110 116 -129 91 -43 -188 98 12 24 -14 -86 -220 110 -184 -42 32 286 235 -68 -83 -403 85 -47 -76 68 -211 -104 22 39 92 51 -81 111 -73 243 57 56 -113 -54 -116 180 36 38 -434 -232 58 164 404 -8 22 117 -143 391 54 66 -194 -55 -193 205 -34 48 -498 -138 -98 312 328 122 -176
-14 -9 -7 -13 -6 -16 -1 5 -12 -3 8 10 4 -11 -1 2 -5	-402 162 -72 164 -84 74 -188 98 12 129 -91 43 25 -19 73 153 -105 -43 220 -110 184 -196 96 -270 -36 -38 434 403 -85 47 -168 17 -130 111 -73 243 -92 -51 81 -12 73 -42 -35 5 -32 54 116 -180 3 -60 67 -6 70 -148 -404 8 -22 172 50 186 -34 48 -498 55 193 -205 -1 -127 11 -83 95 107 -328 -122 176 190 24 136 48 -102 -138
-9 -7 -13 -6 -16 -15 -1 2 -3 8 10 4 -11 -1 2 -5 14	188 -98 -12 -24 14 86 220 -110 184 -153 105 43 178 -124 30 -349 201 -227 36 38 -434 -232 58 164 404 -8 22 -111 73 -243 -57 -56 113 54 116 -180 35 -5 32 -47 78 -74 38 -65 99 6 -70 148 -3 10 -81 -1 -77 25 34 -48 498 138 98 -312 -328 -122 176 83 -95 -107 -84 -32 118 273 -71 29 -48 102 138 238 -78 -2 -402 162 -72
-7 -13 -6 -16 -15 -12 - 3 8 10 4 -11 -1 2 -5 14 9	-220 110 -184 196 -96 270 36 38 -434 349 -201 227 -171 77 -197 117 -143 391 -404 8 -22 172 50 186 -34 48 -498 -54 -116 180 -3 60 -67 6 -70 148 -38 65 -99 -9 13 25 -41 75 -180 1 77 -25 -4 -67 -56 -77 25 255 328 122 -176 -190 -24 -136 -48 102 138 -273 71 -29 189 -103 147 -35 -7 -31 402 -162 72 -164 84 -74 188 -98 -12
-13 -6 -16 -15 -12 -3 8 10 4 -11 -1 2 -5 14 9 7	-36 -38 434 232 -58 -164 -404 8 -22 -117 143 -391 -54 -66 194 55 193 -205 34 -48 498 138 98 -312 -328 -122 176 -6 70 -148 3 -10 81 1 77 -25 41 -75 180 -50 88 -155 37 -142 124 77 -25 -255 -81 -42 199 274 6 4 48 -102 -138 -238 78 2 402 -162 72 35 7 31 154 -110 116 -129 91 -43 -188 98 12 24 -14 -86 -220 110 -184
-6 -16 -15 -12 -3 8 10 4 -11 -1 2 -5 14 9 7 13	404 -8 22 -172 -50 -186 34 -48 498 -55 -193 205 1 127 -11 83 -95 -107 328 122 -176 -190 -24 -136 -48 102 138 -1 -77 25 4 67 56 77 -25 -255 -37 142 -124 -13 -54 -31 -118 100 75 -274 -6 -4 193 -36 203 42 -32 -286 -402 162 -72 164 -84 74 -188 98 12 129 -91 43 25 -19 73 153 -105 -43 220 -110 184 -196 96 -270 -36 -38 434
1 3 13 2 8 -6 5 -10 16 14 4 -15 -9 11 12 7	96 -40 -92 -328 230 -196 596 -464 358 81 3 -53 171 -127 221 -187 237 -215 -136 30 130 -132 204 -292 186 -346 438 -44 62 -44 133 -86 115 -238 220 -180 -72 -27 155 -35 73 -163 33 -161 220 11 29 -121 94 -163 186 -237 329 -403 -8 -84 180 62 -58 -34 -120 24 2 63 51 -257 -101 -19 105 121 85 -225 114 -88 112 -56 122 -80 288 -312
3 13 2 8 -6 5 -10 16 14 4 -15 -9 11 12 7 -1	-596 464 -358 268 -234 162 -136 30 130 187 -237 215 -16 110 6 55 -33 -77 -186 346 -438 54 -142 146 8 84 -180 238 -220 180 -105 134 -65 11 29 -121 -33 161 -220 -2 -88 57 61 -2 -34 237 -329 403 -143 166 -217 -52 -22 136 120 -24 -2 -58 -34 -32 114 -88 112 -121 -85 225 20 66 -120 -177 37 145 -288 312 -368 232 -190 288 96 -40 -
13 2 8 -6 5 -10 16 14 4 -15 -9 11 12 7 -1 -3	136 -30 -130 132 -204 292 -186 346 -438 -55 33 77 39 77 -71 -1 -109 223 -8 -84 180 62 -58 -34 -120 24 2 -11 -29 121 -94 163 -186 237 -329 403 -61 2 34 59 -90 23 -204 168 -183 52 22 -136 -195 144 -81 358 -244 178 -114 88 -112 56 -122 80 -288 312 -368 177 -37 -145 -157 103 25 409 -227 143 -96 40 92 328 -230 196 -596 464 -358

DRAFT-v1

2 8 -6 5 -10 16 14 4 -15 -9 11 12 7 -1 -3 -13	186 -346 438 -54 142 -146 -8 -84 180 1 109 -223 38 -32 152 63 51 -257 120 -24 -2 -58 -34 -32 114 -88 112 -237 329 -403 143 -166 217 52 22 -136 204 -168 183 -145 78 -160 9 -24 102 -358 244 -178 163 -100 97 -125 59 9 288 -312 368 -232 190 -288 -96 40 92 -409 227 -143 252 -124 168 -81 -3 53 596 -464 358 -268 234 -162 136 -30
8 -6 5 -10 16 14 4 -15 -9 11 12 7 -1 -3 -13 -2	8 84 -180 -62 58 34 120 -24 -2 -63 -51 257 101 19 -105 -121 -85 225 -114 88 -112 56 -122 80 -288 312 -368 -52 -22 136 195 -144 81 -358 244 -178 -9 24 -102 -136 54 -58 154 -76 -5 125 -59 -9 38 -41 106 51 17 -35 96 -40 -92 -328 230 -196 596 -464 358 81 3 -53 171 -127 221 -187 237 -215 -136 30 130 -132 204 -292 186 -346 438
-6 5 -10 16 14 4 -15 -9 11 12 7 -1 -3 -13 -2 -8	-120 24 2 58 34 32 -114 88 -112 121 85 -225 -20 -66 120 177 -37 -145 288 -312 368 -232 190 -288 -96 40 92 358 -244 178 -163 100 -97 125 -59 -9 -154 76 5 18 -22 -63 -116 35 111 -51 -17 35 89 -24 71 44 -62 44 -596 464 -358 268 -234 162 -136 30 130 187 -237 215 -16 110 6 55 -33 -77 -186 346 -438 54 -142 146 8 84 -180
5 -10 16 14 4 -15 -9 11 12 7 -1 -3 -13 -2 -8 6	114 -88 112 -56 122 -80 288 -312 368 -177 37 145 157 -103 -25 -409 227 -143 96 -40 -92 -328 230 -196 596 -464 358 -125 59 9 -38 41 -106 -51 -17 35 116 -35 -111 -98 13 48 205 -59 -40 -44 62 -44 133 -86 115 -238 220 -180 136 -30 -130 132 -204 292 -186 346 -438 -55 33 77 39 77 -71 -1 -109 223 -8 -84 180 62 -58 -34 -120 24 2
-10 16 14 4 -15 -9 11 12 7 -1 -3 -13 -2 -8 6 -5	-288 312 -368 232 -190 288 96 -40 -92 409 -227 143 -252 124 -168 81 3 -53 -596 464 -358 268 -234 162 -136 30 130 51 17 -35 -89 24 -71 -44 62 -44 -205 59 40 107 -46 8 -72 -27 155 238 -220 180 -105 134 -65 11 29 -121 186 -346 438 -54 142 -146 -8 -84 180 1 109 -223 38 -32 152 63 51 -257 120 -24 -2 -58 -34 -32 114 -88 112
1 -3 13 -2 8 6 5 10 16 -14 4 15 -9 -11 12 -7	16 40 -172 132 -230 264 -332 464 -570 87 -3 -47 -83 127 -33 287 -237 259 -76 -30 190 276 -204 116 -506 346 -254 80 -62 80 -39 86 -57 202 -220 260 -126 27 101 111 -73 -17 -289 161 -102 69 -29 -63 -232 163 -140 421 -329 255 -176 84 12 -54 58 -150 -72 -24 50 165 -51 -155 -139 19 67 291 -85 -55 -62 88 -64 188 -122 164 -336 312
-3 13 -2 8 6 5 10 16 -14 4 15 -9 -11 12 -7 -1	332 -464 570 -200 234 -306 -76 -30 190 -287 237 -259 204 -110 226 -11 33 -143 506 -346 254 -230 142 -138 176 -84 -12 -202 220 -260 163 -134 203 69 -29 -63 289 -161 102 -178 88 -119 57 2 -38 -421 329 -255 189 -166 115 -96 22 92 72 24 -50 -126 34 -100 -62 88 -64 -291 85 55 152 -66 12 -103 -37 219 336 -312 256 -148 190 -92 16
13 -2 8 6 5 10 16 -14 4 15 -9 -11 12 -7 -1 3	76 30 -190 -276 204 -116 506 -346 254 11 -33 143 193 -77 83 -219 109 5 -176 84 12 -54 58 -150 -72 -24 50 -69 29 63 232 -163 140 -421 329 -255 -57 -2 38 -121 90 -157 132 -168 153 96 -22 -92 93 -144 207 -130 244 -310 62 -88 64 -188 122 -164 336 -312 256 103 37 -219 49 -103 231 -45 227 -311 -16 -40 172 -132 230 -264 332 -464
-2 8 6 5 10 16 -14 4 15 -9 -11 12 -7 -1 3 -13	-506 346 -254 230 -142 138 -176 84 12 219 -109 -5 -26 32 88 165 -51 -155 72 24 -50 -126 34 -100 -62 88 -64 421 -329 255 -189 166 -115 96 -22 -92 -132 168 -153 11 -78 -4 -39 24 54 130 -244 310 -37 100 -103 -7 -59 127 -336 312 -256 148 -190 92 -16 -40 172 45 -227 311 4 124 -80 -87 3 47 -332 464 -570 200 -234 306 76 30 -190
8 6 5 10 16 -14 4 15 -9 -11 12 -7 -1 3 -13 2	176 -84 -12 54 -58 150 72 24 -50 -165 51 155 139 -19 -67 -291 85 55 62 -88 64 -188 122 -164 336 -312 256 -96 22 92 -93 144 -207 130 -244 310 39 -24 -54 -28 -54 50 2 76 -157 7 59 -127 -44 41 24 85 -17 -1 16 40 -172 132 -230 264 -332 464 -570 87 -3 -47 -83 127 -33 287 -237 259 -76 -30 190 276 -204 116 -506 346 -254
6 5 10 16 -14 4 15 -9 -11 12 -7 -1 3 -13 2 -8	-72 -24 50 126 -34 100 62 -88 64 291 -85 -55 -152 66 -12 103 37 -219 -336 312 -256 148 -190 92 -16 -40 172 -130 244 -310 37 -100 103 7 59 -127 -2 -76 157 -26 22 -107 -46 -35 181 -85 17 1 41 24 23 -80 62 -80 332 -464 570 -200 234 -306 -76 -30 190 -287 237 -259 204 -110 226 -11 33 -143 506 -346 254 -230 142 -138 176 -84 -12
5 10 16 -14 4 15 -9 -11 12 -7 -1 3 -13 2 -8 -6	-62 88 -64 188 -122 164 -336 312 -256 -103 -37 219 -49 103 -231 45 -227 311 16 40 -172 132 -230 264 -332 464 -570 -7 -59 127 44 -41 -24 -85 17 1 46 35 -181 -72 -13 74 87 59 -158 80 -62 80 -39 86 -57 202 -220 260 76 30 -190 -276 204 -116 506 -346 254 11 -33 143 193 -77 83 -219 109 5 -176 84 12 -54 58 -150 -72 -24 50
10 16 -14 4 15 -9 -11 12 -7 -1 3 -13 2 -8 -6 -5	336 -312 256 -148 190 -92 16 40 -172 -45 227 -311 -4 -124 80 87 -3 -47 332 -464 570 -200 234 -306 -76 -30 190 85 -17 -1 -41 -24 -23 80 -62 80 -87 -59 158 15 46 -84 -126 27 101 -202 220 -260 163 -134 203 69 -29 -63 -506 346 -254 230 -142 138 -176 84 12 219 -109 -5 -26 32 88 165 -51 -155 72 24 -50 -126 34 -100 -62 88 -64
1 6 4 -7 -8 14 -12 -2 16 -11 -13 -10 9 -3 5 15	48 -70 528 152 84 -306 -452 -6 54 -221 213 -427 -17 -103 197 79 135 -175 102 -54 328 198 -24 -76 -200 -74 164 -53 109 -373 -46 -67 218 207 57 -41 80 -101 273 69 13 -103 -81 -91 96 66 -50 -274 -227 60 97 328 -4 -30 58 -148 218 -60 50 -130 38 -108 28 61 -11 -119 -121 77 9 83 47 -17 -234 154 220 256 -96 -118 -456 82 -104
6 4 -7 -8 14 -12 -2 16 -11 -13 -10 9 -3 5 15 -1	452 6 -54 -300 78 -252 102 -54 328 -79 -135 175 62 32 22 119 -159 99 200 74 -164 -2 -98 88 -58 148 -218 -207 -57 41 161 -10 177 66 -50 -274 81 91 -96 -12 -78 -7 -146 151 1 -328 4 30 101 56 67 5 -39 -155 -38 108 -28 -22 -58 -102 -234 154 220 -83 -47 17 -38 124 -8 173 -143 -101 456 -82 104 -200 -14 -222 48 -70 528
4 -7 -8 14 -12 -2 16 -11 -13 -10 9 -3 5 15 -1 -6	-102 54 -328 -198 24 76 200 74 -164 -119 159 -99 181 -127 121 -121 61 -11 58 -148 218 -60 50 -130 38 -108 28 -66 50 274 227 -60 -97 -328 4 30 146 -151 -1 -158 73 -6 247 -95 66 -5 39 155 106 17 -88 -245 51 13 234 -154 -220 -256 96 118 456 -82 104 -173 143 101 135 -19 -109 -373 129 -121 -48 70 -528 -152 -84 306 452 6 -54
-7 -8 14 -12 -2 16 -11 -13 -10 9 -3 5 15 -1 -6 -4	-200 -74 164 2 98 -88 58 -148 218 121 -61 11 60 -66 110 61 -11 -119 -38 108 -28 -22 -58 -102 -234 154 220 328 -4 -30 -101 -56 -67 -5 39 155 -247 95 -66 89 -22 60 -141 112 -154 245 -51 -13 -139 68 -75 168 -104 54 -456 82 -104 200 14 222 -48 70 -528 373 -129 121 -238 110 -230 221 -213 427 -452 -6 54 300 -78 252 -102 54 -328

DRAFT-v1

-8 14 -12 -2 16 -11 -13 -10 9 -3 5 15 -1 -6 -4 7	-58 148 -218 60 -50 130 -38 108 -28 -61 11 119 121 -77 -9 -83 -47 17 234 -154 -220 -256 96 118 456 -82 104 5 -39 -155 -106 -17 88 245 -51 -13 141 -112 154 -52 90 -94 2 -44 79 -168 104 -54 29 -36 -21 -128 78 -134 48 -70 528 152 84 -306 -452 -6 54 -221 213 -427 -17 -103 197 79 135 -175 102 -54 328 198 -24 -76 -200 -74 164
14 -12 -2 16 -11 -13 -10 9 -3 5 15 -1 -6 -4 7 8	38 -108 28 22 58 102 234 -154 -220 83 47 -17 38 -124 8 -173 143 101 -456 82 -104 200 14 222 -48 70 -528 -245 51 13 139 -68 75 -168 104 -54 -2 44 -79 -50 46 -15 27 8 -100 128 -78 134 -99 42 -155 53 -109 373 452 6 -54 -300 78 -252 102 -54 328 -79 -135 175 62 32 22 119 -159 99 200 74 -164 -2 -98 88 -58 148 -218
-12 -2 16 -11 -13 -10 9 -3 5 15 -1 -6 -4 7 8 -14	-234 154 220 256 -96 -118 -456 82 -104 173 -143 -101 -135 19 109 373 -129 121 48 -70 528 152 84 -306 -452 -6 54 168 -104 54 -29 36 21 128 -78 134 -27 -8 100 -23 54 -115 -126 34 -55 -53 109 -373 -46 -67 218 207 57 -41 -102 54 -328 -198 24 76 200 74 -164 -119 159 -99 181 -127 121 -121 61 -11 58 -148 218 -60 50 -130 38 -108 2
-2 16 -11 -13 -10 9 -3 5 15 -1 -6 -4 7 8 -14 12	456 -82 104 -200 -14 -222 48 -70 528 -373 129 -121 238 -110 230 -221 213 -427 452 6 -54 -300 78 -252 102 -54 328 -128 78 -134 99 -42 155 -53 109 -373 126 -34 55 -149 88 -170 80 -101 273 -207 -57 41 161 -10 177 66 -50 -274 -200 -74 164 2 98 -88 58 -148 218 121 -61 11 60 -66 110 61 -11 -119 -38 108 -28 -22 -58 -102 -234 154
1 -6 4 7 -8 -14 -12 2 16 11 -13 10 9 3 5 -15	-92 70 388 320 -84 -138 -464 6 42 205 -213 -1 -223 103 -9 349 -135 95 -6 54 220 150 24 -124 -348 74 16 165 -109 -155 -180 67 84 321 -57 73 -122 101 71 95 -13 -77 -263 91 -86 -34 50 -374 -107 -60 217 320 4 -38 -238 148 -78 40 -50 -30 -178 108 -188 39 11 -141 33 -77 163 177 -47 77 74 -154 528 64 96 -310 -292 -82 60
-6 4 7 -8 -14 -12 2 16 11 -13 10 9 3 5 -15 -1	464 -6 -42 -144 -78 -96 -6 54 220 -349 135 -95 126 -32 86 -199 159 -219 348 -74 -16 -198 98 -108 238 -148 78 -321 57 -73 141 10 157 -34 50 -374 263 -91 86 -168 78 -163 156 -151 303 -320 -4 38 213 -56 179 -73 39 -233 178 -108 188 -138 58 -218 74 -154 528 -177 47 -77 210 -124 240 -113 143 -387 292 82 -60 -228 14 -250 -92 70
4 7 -8 -14 -12 2 16 11 -13 10 9 3 5 -15 -1 6	6 -54 -220 -150 -24 124 348 -74 -16 199 -159 219 -73 127 -133 1 -61 111 -238 148 -78 40 -50 -30 -178 108 -188 34 -50 374 107 60 -217 -320 -4 38 -156 151 -303 -12 -73 140 57 95 -124 73 -39 233 140 -17 -54 -143 -51 115 -74 154 -528 -64 -96 310 292 82 -60 113 -143 387 97 19 -147 -115 -129 137 92 -70 -388 -320 84 138 464 -6 -4
7 -8 -14 -12 2 16 11 -13 10 9 3 5 -15 -1 6 -4	-348 74 16 198 -98 108 -238 148 -78 -1 61 -111 -72 66 -22 39 11 -141 178 -108 188 -138 58 -218 74 -154 528 320 4 -38 -213 56 -179 73 -39 233 -57 -95 124 45 22 16 83 -112 70 143 51 -115 -3 -68 61 -40 104 -154 -292 -82 60 228 -14 250 92 -70 -388 115 129 -137 -18 -110 -10 -205 213 1 -464 6 42 144 78 96 6 -54 -220
-8 -14 -12 2 16 11 -13 10 9 3 5 -15 -1 6 -4 -7	238 -148 78 -40 50 30 178 -108 188 -39 -11 141 -33 77 -163 -177 47 -77 -74 154 -528 -64 -96 310 292 82 -60 -73 39 -233 -140 17 54 143 51 -115 -83 112 -70 128 -90 86 -86 44 -9 40 -104 154 -43 36 -93 28 -78 22 -92 70 388 320 -84 -138 -464 6 42 205 -213 -1 -223 103 -9 349 -135 95 -6 54 220 150 24 -124 -348 74 16
-14 -12 2 16 11 -13 10 9 3 5 -15 -1 6 -4 -7 8	-178 108 -188 138 -58 218 -74 154 -528 177 -47 77 -210 124 -240 113 -143 387 -292 -82 60 228 -14 250 92 -70 -388 -143 -51 115 3 68 -61 40 -104 154 86 -44 9 42 -46 77 43 -8 -84 -28 78 -22 -15 -42 -71 -165 109 155 464 -6 -42 -144 -78 -96 -6 54 220 -349 135 -95 126 -32 86 -199 159 -219 348 -74 -16 -198 98 -108 238 -148 78
-12 2 16 11 -13 10 9 3 5 -15 -1 6 -4 -7 8 14	74 -154 528 64 96 -310 -292 -82 60 -113 143 -387 -97 -19 147 115 129 -137 -92 70 388 320 -84 -138 -464 6 42 -40 104 -154 43 -36 93 -28 78 -22 -43 8 84 85 -54 -7 -58 -34 13 165 -109 -155 -180 67 84 321 -57 73 6 -54 -220 -150 -24 124 348 -74 -16 199 -159 219 -73 127 -133 1 -61 111 -238 148 -78 40 -50 -30 -178 108 -188
2 16 11 -13 10 9 3 5 -15 -1 6 -4 -7 8 14 12	292 82 -60 -228 14 -250 -92 70 388 -115 -129 137 18 110 10 205 -213 -1 464 -6 -42 -144 -78 -96 -6 54 220 28 -78 22 15 42 71 165 -109 -155 58 34 -13 27 -88 6 -122 101 71 -321 57 -73 141 10 157 -34 50 -374 -348 74 16 198 -98 108 -238 148 -78 -1 61 -111 -72 66 -22 39 11 -141 178 -108 188 -138 58 -218 74 -154 528
1 7 -12 11 9 -15 -4 14 -16 -10 -5 -6 -8 2 -13 3	-172 40 16 -92 190 -148 256 -312 336 219 -37 -103 12 -66 152 55 85 -291 -64 88 -62 -100 34 -126 -50 24 72 92 22 -96 115 -166 189 -255 329 -421 -38 2 57 -119 88 -178 102 -161 289 -63 -29 69 203 -134 163 -260 220 -202 -12 -84 176 -138 142 -230 254 -346 506 -143 33 -11 226 -110 204 -259 237 -287 190 -30 -76 -306 234 -200 570
7 -12 11 9 -15 -4 14 -16 -10 -5 -6 -8 2 -13 3 -1	-256 312 -336 164 -122 188 -64 88 -62 -55 -85 291 67 19 -139 -155 -51 165 50 -24 -72 -150 58 -54 12 84 -176 255 -329 421 -140 163 -232 -63 -29 69 -102 161 -289 -17 -73 111 101 27 -126 260 -220 202 -57 86 -39 80 -62 80 -254 346 -506 116 -204 276 190 -30 -76 259 -237 287 -33 127 -83 -47 -3 87 -570 464 -332 264 -230 132 -172
-12 11 9 -15 -4 14 -16 -10 -5 -6 -8 2 -13 3 -1 -7	64 -88 62 100 -34 126 50 -24 -72 155 51 -165 -88 -32 26 5 109 -219 -12 -84 176 -138 142 -230 254 -346 506 63 29 -69 -203 134 -163 260 -220 202 -101 -27 126 84 -46 -15 -158 59 87 -80 62 -80 23 24 41 1 17 -85 -190 30 76 306 -234 200 -570 464 -332 47 3 -87 -80 124 4 311 -227 45 172 -40 -16 92 -190 148 -256 312 -336
11 9 -15 -4 14 -16 -10 -5 -6 -8 2 -13 3 -1 -7 12	-50 24 72 150 -58 54 -12 -84 176 -5 -109 219 -83 77 -193 -143 33 -11 -254 346 -506 116 -204 276 190 -30 -76 -260 220 -202 57 -86 39 -80 62 -80 158 -59 -87 -74 13 72 181 -35 -46 -1 -17 85 24 41 -44 -127 59 7 570 -464 332 -264 230 -132 172 -40 -16 -311 227 -45 231 -103 49 -219 37 103 256 -312 336 -164 122 -188 64 -88 62
9 -15 -4 14 -16 -10 -5 -6 -8 2 -13 3 -1 -7 12 -11	12 84 -176 138 -142 230 -254 346 -506 143 -33 11 -226 110 -204 259 -237 287 -190 30 76 306 -234 200 -570 464 -332 80 -62 80 -23 -24 -41 -1 -17 85 -181 35 46 107 -22 26 -157 76 2 127 -59 -7 -103 100 -37 310 -244 130 -172 40 16 -92 190 -148 256 -312 336 219 -37 -103 12 -66 152 55 85 -291 -64 88 -62 -100 34 -126 -50 24 72

DRAFT-v1

-15 -4 14 -16 -10 -5 -6 -8 2 -13 3 -1 -7 12 -11 -9	254 -346 506 -116 204 -276 -190 30 76 -259 237 -287 33 -127 83 47 3 -87 570 -464 332 -264 230 -132 172 -40 -16 1 17 -85 -24 -41 44 127 -59 -7 157 -76 -2 -50 54 28 54 24 -39 -310 244 -130 207 -144 93 -92 -22 96 -256 312 -336 164 -122 188 -64 88 -62 -55 -85 291 67 19 -139 -155 -51 165 50 -24 -72 -150 58 -54 12 84 -176
-4 14 -16 -10 -5 -6 -8 2 -13 3 -1 -7 12 -11 -9 15	190 -30 -76 -306 234 -200 570 -464 332 -47 -3 87 80 -124 -4 -311 227 -45 -172 40 16 -92 190 -148 256 -312 336 -127 59 7 103 -100 37 -310 244 -130 -54 -24 39 4 78 -11 153 -168 132 92 22 -96 115 -166 189 -255 329 -421 64 -88 62 100 -34 126 50 -24 -72 155 51 -165 -88 -32 26 5 109 -219 -12 -84 176 -138 142 -230 254 -346 506
14 -16 -10 -5 -6 -8 2 -13 3 -1 -7 12 -11 -9 15 4	-570 464 -332 264 -230 132 -172 40 16 311 -227 45 -231 103 -49 219 -37 -103 -256 312 -336 164 -122 188 -64 88 -62 310 -244 130 -207 144 -93 92 22 -96 -153 168 -132 157 -90 121 -38 2 57 255 -329 421 -140 163 -232 -63 -29 69 -50 24 72 150 -58 54 -12 -84 176 -5 -109 219 -83 77 -193 -143 33 -11 -254 346 -506 116 -204 276 190 -
1 -7 -12 -11 9 15 -4 -14 -16 10 -5 6 -8 -2 -13 -3	-92 -40 96 288 -190 232 -368 312 -288 145 37 -177 -120 66 20 225 -85 -121 112 -88 114 -32 -34 -58 -2 -24 120 136 -22 -52 -217 166 -143 403 -329 237 -34 -2 61 57 -88 -2 -220 161 -33 -121 29 11 -65 134 -105 180 -220 238 -180 84 8 146 -142 54 -438 346 -186 -77 -33 55 6 110 -16 215 -237 187 130 30 -136 162 -234 268 -358 464 -5
-7 -12 -11 9 15 -4 -14 -16 10 -5 6 -8 -2 -13 -3 -1	368 -312 288 -80 122 -56 112 -88 114 -225 85 121 105 -19 -101 -257 51 63 2 24 -120 -34 -58 62 180 -84 -8 -403 329 -237 186 -163 94 -121 29 11 220 -161 33 -163 73 -35 155 -27 -72 -180 220 -238 115 -86 133 -44 62 -44 438 -346 186 -292 204 -132 130 30 -136 -215 237 -187 221 -127 171 -53 3 81 358 -464 596 -196 230 -328 -92 -40
-12 -11 9 15 -4 -14 -16 10 -5 6 -8 -2 -13 -3 -1 7	-112 88 -114 32 34 58 2 24 -120 257 -51 -63 -152 32 -38 223 -109 -1 -180 84 8 146 -142 54 -438 346 -186 121 -29 -11 65 -134 105 -180 220 -238 -155 27 72 -8 46 -107 -40 -59 205 44 -62 44 71 -24 89 35 -17 -51 -130 -30 136 -162 234 -268 358 -464 596 53 -3 -81 168 -124 252 -143 227 -409 92 40 -96 -288 190 -232 368 -312 288
-11 9 15 -4 -14 -16 10 -5 6 -8 -2 -13 -3 -1 7 12	-2 -24 120 34 58 -62 -180 84 8 -223 109 1 71 -77 -39 -77 -33 55 438 -346 186 -292 204 -132 130 30 -136 180 -220 238 -115 86 -133 44 -62 44 40 59 -205 -48 -13 98 111 35 -116 -35 17 51 106 -41 38 -9 -59 125 -358 464 -596 196 -230 328 92 40 -96 143 -227 409 25 103 -157 -145 -37 177 -368 312 -288 80 -122 56 -112 88 -114
9 15 -4 -14 -16 10 -5 6 -8 -2 -13 -3 -1 7 12 11	180 -84 -8 -146 142 -54 438 -346 186 77 33 -55 -6 -110 16 -215 237 -187 -130 -30 136 -162 234 -268 358 -464 596 -44 62 -44 -71 24 -89 -35 17 51 -111 -35 116 63 22 -18 -5 -76 154 9 59 -125 97 -100 163 -178 244 -358 -92 -40 96 288 -190 232 -368 312 -288 145 37 -177 -120 66 20 225 -85 -121 112 -88 114 -32 -34 -58 -2 -24 120
15 -4 -14 -16 10 -5 6 -8 -2 -13 -3 -1 7 12 11 -9	-438 346 -186 292 -204 132 -130 -30 136 215 -237 187 -221 127 -171 53 -3 -81 -358 464 -596 196 -230 328 92 40 -96 35 -17 -51 -106 41 -38 9 59 -125 5 76 -154 58 -54 136 102 -24 9 178 -244 358 -81 144 -195 -136 22 52 368 -312 288 -80 122 -56 112 -88 114 -225 85 121 105 -19 -101 -257 51 63 2 24 -120 -34 -58 62 180 -84 -8
-4 -14 -16 10 -5 6 -8 -2 -13 -3 -1 7 12 11 -9 -15	130 30 -136 162 -234 268 -358 464 -596 -53 3 81 -168 124 -252 143 -227 409 -92 -40 96 288 -190 232 -368 312 -288 -9 -59 125 -97 100 -163 178 -244 358 -102 24 -9 160 -78 145 -183 168 -204 136 -22 -52 -217 166 -143 403 -329 237 -112 88 -114 32 34 58 2 24 -120 257 -51 -63 -152 32 -38 223 -109 -1 -180 84 8 146 -142 54 -438 346
-14 -16 10 -5 6 -8 -2 -13 -3 -1 7 12 11 -9 -15 4	358 -464 596 -196 230 -328 -92 -40 96 -143 227 -409 -25 -103 157 145 37 -177 368 -312 288 -80 122 -56 112 -88 114 -178 244 -358 81 -144 195 136 -22 -52 183 -168 204 -23 90 -59 -34 -2 61 -403 329 -237 186 -163 94 -121 29 11 -2 -24 120 34 58 -62 -180 84 8 -223 109 1 71 -77 -39 -77 -33 55 438 -346 186 -292 204 -132 130 30 -13
1 10 12 -6 9 -2 4 3 -16 7 5 -11 -8 -15 13 -14	-136 200 -340 44 -142 184 202 -62 -46 261 -187 155 -56 110 -24 15 17 17 -546 438 -280 300 -234 142 -162 4 84 -98 110 -82 75 -24 47 -93 65 -19 -107 9 112 53 -22 -68 -89 -32 84 187 -141 43 -169 100 -71 54 44 -120 332 -420 504 -194 190 -278 -16 -68 84 -47 169 -379 -50 -66 160 163 47 -185 172 -156 194 38 34 0 54 -92 156
10 12 -6 9 -2 4 3 -16 7 5 -11 -8 -15 13 -14 -1	-202 62 46 246 -204 138 -546 438 -280 -15 -17 -17 -41 127 -7 285 -251 125 162 -4 -84 138 -230 226 -332 420 -504 93 -65 19 -18 41 28 187 -141 43 89 32 -84 -36 -54 16 -80 132 -155 -54 -44 120 -115 144 -191 234 -310 422 16 68 -84 -210 122 -194 172 -156 194 -163 -47 185 113 -19 -25 -125 -13 185 -54 92 -156 92 -58 156 -136 200
12 -6 9 -2 4 3 -16 7 5 -11 -8 -15 13 -14 -1 -10	546 -438 280 -300 234 -142 162 -4 -84 -285 251 -125 244 -124 118 -147 21 101 332 -420 504 -194 190 -278 -16 -68 84 -187 141 -43 169 -100 71 -54 -44 120 80 -132 155 -116 78 -139 -35 12 -36 -234 310 -422 119 -166 231 109 3 -65 -172 156 -194 -38 -34 0 -54 92 -156 125 13 -185 -12 -32 160 217 -45 -29 136 -200 340 -44 142 -184 -
-6 9 -2 4 3 -16 7 5 -11 -8 -15 13 -14 -1 -10 -12	-162 4 84 -138 230 -226 332 -420 504 147 -21 -101 97 -103 219 -47 169 -379 16 68 -84 -210 122 -194 172 -156 194 54 44 -120 115 -144 191 -234 310 -422 35 -12 36 -151 90 -175 154 -178 267 -109 -3 65 228 -163 166 -359 297 -237 54 -92 156 -92 58 -156 136 -200 340 -217 45 29 205 -77 131 -261 187 -155 202 -62 -46 -246 204 -138 5
9 -2 4 3 -16 7 5 -11 -8 -15 13 -14 -1 -10 -12 6	-332 420 -504 194 -190 278 16 68 -84 47 -169 379 50 66 -160 -163 -47 185 -172 156 -194 -38 -34 0 -54 92 -156 234 -310 422 -119 166 -231 -109 -3 65 -154 178 -267 3 -88 92 74 15 -101 359 -297 237 -131 134 -71 108 -48 36 -136 200 -340 44 -142 184 202 -62 -46 261 -187 155 -56 110 -24 15 17 17 -546 438 -280 300 -234 142 -162 4
-2 4 3 -16 7 5 -11 -8 -15 13 -14 -1 -10 -12 6 -9	-16 -68 84 210 -122 194 -172 156 -194 163 47 -185 -113 19 25 125 13 -185 54 -92 156 -92 58 -156 136 -200 340 109 3 -65 -228 163 -166 359 -297 237 -74 -15 101 77 -73 -9 -205 119 30 -108 48 -36 -23 86 -35 98 -110 82 -202 62 46 246 -204 138 -546 438 -280 -15 -17 -17 -41 127 -7 285 -251 125 162 -4 -84 138 -230 226 -332 420 -50

DRAFT-v1

4 3 -16 7 5 -11 -8 -15 13 -14 -1 -10 -12 6 -9 2	172 -156 194 38 34 0 54 -92 156 -125 -13 185 12 32 -160 -217 45 29 -136 200 -340 44 -142 184 202 -62 -46 -359 297 -237 131 -134 71 -108 48 -36 205 -119 -30 -128 46 21 182 -33 -65 -98 110 -82 75 -24 47 -93 65 -19 546 -438 280 -300 234 -142 162 -4 -84 -285 251 -125 244 -124 118 -147 21 101 332 -420 504 -194 190 -278 -16 -68
3 -16 7 5 -11 -8 -15 13 -14 -1 -10 -12 6 -9 2 -4	-54 92 -156 92 -58 156 -136 200 -340 217 -45 -29 -205 77 -131 261 -187 155 -202 62 46 246 -204 138 -546 438 -280 108 -48 36 23 -86 35 -98 110 -82 -182 33 65 54 13 -44 -107 9 112 93 -65 19 -18 41 28 187 -141 43 -162 4 84 -138 230 -226 332 -420 504 147 -21 -101 97 -103 219 -47 169 -379 16 68 -84 -210 122 -194 172 -156 194
1 -10 12 6 9 2 4 -3 -16 -7 5 11 -8 15 13 14	264 -200 60 -240 142 -100 78 62 -170 -113 187 -219 164 -110 196 49 -17 51 330 -438 596 -168 234 -326 -154 -4 92 122 -110 138 27 24 -1 37 -65 111 -89 -9 130 9 22 -112 -153 32 20 -95 141 -239 31 -100 129 142 -44 -32 -508 420 -336 186 -190 102 -152 68 -52 291 -169 -41 -182 66 28 257 -47 -91 -140 156 -118 106 -34 68 -130 92 -2
-10 12 6 9 2 4 -3 -16 -7 5 11 -8 15 13 14 -1	-78 -62 170 -162 204 -270 330 -438 596 -49 17 -51 213 -127 247 -217 251 -377 154 4 -92 -322 230 -234 508 -420 336 -37 65 -111 64 -41 110 -95 141 -239 153 -32 -20 -144 54 -92 184 -132 109 -142 44 32 173 -144 97 -386 310 -198 152 -68 52 34 -122 50 -140 156 -118 -257 47 91 75 19 -63 -151 13 159 130 -92 28 -24 58 40 264 -200 6
12 6 9 2 4 -3 -16 -7 5 11 -8 15 13 14 -1 10	-330 438 -596 168 -234 326 154 4 -92 217 -251 377 -4 124 -130 -105 -21 143 -508 420 -336 186 -190 102 -152 68 -52 95 -141 239 -31 100 -129 -142 44 32 -184 132 -109 40 -78 17 -11 -12 -12 386 -310 198 -213 166 -101 115 -3 -59 140 -156 118 -106 34 -68 130 -92 28 151 -13 -159 -76 32 96 127 45 -119 -264 200 -60 240 -142 100 -78
6 9 2 4 -3 -16 -7 5 11 -8 15 13 14 -1 10 -12	-154 -4 92 322 -230 234 -508 420 -336 105 21 -143 -109 103 13 291 -169 -41 152 -68 52 34 -122 50 -140 156 -118 142 -44 -32 -173 144 -97 386 -310 198 11 12 12 29 -90 5 -202 178 -89 -115 3 59 -98 163 -160 235 -297 357 -130 92 -28 24 -58 -40 -264 200 -60 -127 -45 119 51 77 -23 113 -187 219 78 62 -170 162 -204 270 -330 438 -59
9 2 4 -3 -16 -7 5 11 -8 15 13 14 -1 10 -12 -6	508 -420 336 -186 190 -102 152 -68 52 -291 169 41 182 -66 -28 -257 47 91 140 -156 118 -106 34 -68 130 -92 28 -386 310 -198 213 -166 101 -115 3 59 202 -178 89 -173 88 -84 104 -15 -71 -235 297 -357 137 -134 197 12 48 -60 264 -200 60 -240 142 -100 78 62 -170 -113 187 -219 164 -110 196 49 -17 51 330 -438 596 -168 234 -326 -154
2 4 -3 -16 -7 5 11 -8 15 13 14 -1 10 -12 -6 -9	-152 68 -52 -34 122 -50 140 -156 118 257 -47 -91 -75 -19 63 151 -13 -159 -130 92 -28 24 -58 -40 -264 200 -60 115 -3 -59 98 -163 160 -235 297 -357 -104 15 71 -69 73 -155 33 -119 268 -12 -48 60 149 -86 137 -122 110 -138 -78 -62 170 -162 204 -270 330 -438 596 -49 17 -51 213 -127 247 -217 251 -377 154 4 -92 -322 230 -234 508 -
4 -3 -16 -7 5 11 -8 15 13 14 -1 10 -12 -6 -9 -2	-140 156 -118 106 -34 68 -130 92 -28 -151 13 159 76 -32 -96 -127 -45 119 264 -200 60 -240 142 -100 78 62 -170 235 -297 357 -137 134 -197 -12 -48 60 -33 119 -268 -36 -46 113 116 33 -131 122 -110 138 27 24 -1 37 -65 111 -330 438 -596 168 -234 326 154 4 -92 217 -251 377 -4 124 -130 -105 -21 143 -508 420 -336 186 -190 102 -152
-3 -16 -7 5 11 -8 15 13 14 -1 10 -12 -6 -9 -2 -4	130 -92 28 -24 58 40 264 -200 60 127 45 -119 -51 -77 23 -113 187 -219 -78 -62 170 -162 204 -270 330 -438 596 12 48 -60 -149 86 -137 122 -110 138 -116 -33 131 80 -13 -18 -89 -9 130 -37 65 -111 64 -41 110 -95 141 -239 -154 -4 92 322 -230 234 -508 420 -336 105 21 -143 -109 103 13 291 -169 -41 152 -68 52 34 -122 50 -140 156 -1
1 11 -4 -10 -8 3 12 15 16 6 13 7 9 14 -5 2	498 -48 34 -186 -50 -172 22 -8 404 -391 143 -117 197 -77 171 -227 201 -349 434 -38 -36 -270 96 -196 184 -110 220 -243 73 -111 130 -17 168 -47 85 -403 211 -68 76 -172 90 -180 128 -136 311 -286 -32 42 203 -36 193 -4 -6 -274 -12 -98 188 -74 84 -164 72 -162 402 -31 -7 -35 147 -103 189 -29 71 -273 138 102 -48 -136 -24 -190 -176
11 -4 -10 -8 3 12 15 16 6 13 7 9 14 -5 2 -1	-22 8 -404 -164 -58 232 434 -38 -36 227 -201 349 -30 124 -178 -43 -105 153 -184 110 -220 -86 -14 24 12 98 -188 47 -85 403 83 68 -235 -286 -32 42 -128 136 -311 -44 -46 131 75 100 -118 4 6 274 199 -42 -81 -255 -25 77 -72 162 -402 -2 -78 238 138 102 -48 29 -71 273 118 -32 -84 -107 -95 83 176 -122 -328 -312 98 138 498 -48 34
-4 -10 -8 3 12 15 16 6 13 7 9 14 -5 2 -1 -11	-434 38 36 270 -96 196 -184 110 -220 43 105 -153 -73 19 -25 -43 91 -129 -12 -98 188 -74 84 -164 72 -162 402 286 32 -42 -203 36 -193 4 6 274 -75 -100 118 31 54 13 124 -142 37 255 25 -77 -56 -67 -4 -25 77 1 -138 -102 48 136 24 190 176 -122 -328 107 95 -83 11 -127 -1 -205 193 55 -498 48 -34 186 50 172 -22 8 -404
-10 -8 3 12 15 16 6 13 7 9 14 -5 2 -1 -11 4	184 -110 220 86 14 -24 -12 -98 188 43 -91 129 -116 110 -154 -31 -7 -35 -72 162 -402 -2 -78 238 138 102 -48 -4 -6 -274 -199 42 81 255 25 -77 -124 142 -37 155 -88 50 -180 75 -41 25 -77 -1 -81 10 -3 148 -70 6 -176 122 328 312 -98 -138 -498 48 -34 205 -193 -55 -194 66 54 391 -143 117 22 -8 404 164 58 -232 -434 38 36
-8 3 12 15 16 6 13 7 9 14 -5 2 -1 -11 4 10	12 98 -188 74 -84 164 -72 162 -402 31 7 35 -147 103 -189 29 -71 273 -138 -102 48 136 24 190 176 -122 -328 -255 -25 77 56 67 4 25 -77 -1 180 -75 41 -25 -13 9 99 -65 38 -148 70 -6 67 -60 3 -180 116 54 498 -48 34 -186 -50 -172 22 -8 404 -391 143 -117 197 -77 171 -227 201 -349 434 -38 -36 -270 96 -196 184 -110 220
3 12 15 16 6 13 7 9 14 -5 2 -1 -11 4 10 8	72 -162 402 2 78 -238 -138 -102 48 -29 71 -273 -118 32 84 107 95 -83 -176 122 328 312 -98 -138 -498 48 -34 -25 77 1 81 -10 3 -148 70 -6 -99 65 -38 74 -78 47 -32 5 -35 180 -116 -54 -113 56 57 243 -73 111 -22 8 -404 -164 -58 232 434 -38 -36 227 -201 349 -30 124 -178 -43 -105 153 -184 110 -220 -86 -14 24 12 98 -188
12 15 16 6 13 7 9 14 -5 2 -1 -11 4 10 8 -3	138 102 -48 -136 -24 -190 -176 122 328 -107 -95 83 -11 127 1 205 -193 -55 498 -48 34 -186 -50 -172 22 -8 404 148 -70 6 -67 60 -3 180 -116 -54 32 -5 35 42 -73 12 -81 51 92 -243 73 -111 130 -17 168 -47 85 -403 -434 38 36 270 -96 196 -184 110 -220 43 105 -153 -73 19 -25 -43 91 -129 -12 -98 188 -74 84 -164 72 -162 402

DRAFT-v1

15 16 6 13 7 9 14 -5 2 -1 -11 4 10 8 -3 -12	176 -122 -328 -312 98 138 498 -48 34 -205 193 55 194 -66 -54 -391 143 -117 -22 8 -404 -164 -58 232 434 -38 -36 -180 116 54 113 -56 -57 -243 73 -111 81 -51 -92 -39 -22 104 211 -68 76 47 -85 403 83 68 -235 -286 -32 42 184 -110 220 86 14 -24 -12 -98 188 43 -91 129 -116 110 -154 -31 -7 -35 -72 162 -402 -2 -78 238 138 102 -48
1 -11 -4 10 -8 -3 12 -15 16 -6 13 -7 9 -14 -5 -2	402 48 -62 -286 50 -272 6 8 388 -105 -143 169 43 77 17 175 -201 53 358 38 -112 -78 -96 -4 -36 110 0 -97 -73 35 96 17 134 123 -85 -233 75 68 -60 8 -90 0 -144 136 39 -350 32 -22 131 36 121 -16 6 -286 -208 98 -8 94 -84 4 -252 162 78 -45 7 -49 -59 103 -17 113 -71 -131 342 -102 156 -184 24 -238 68 -122 572
-11 -4 10 -8 -3 12 -15 16 -6 13 -7 9 -14 -5 -2 -1	-6 -8 -388 -280 58 116 358 38 -112 -175 201 -53 218 -124 70 -253 105 -57 36 -110 0 -114 14 -4 208 -98 8 -123 85 233 219 -68 -99 -350 32 -22 144 -136 -39 -136 46 39 275 -100 82 16 -6 286 115 42 -165 -305 25 27 252 -162 -78 -158 78 82 342 -102 156 -113 71 131 54 32 -148 -297 95 -107 -68 122 -572 -116 -98 334 402 48 -62
-4 10 -8 -3 12 -15 16 -6 13 -7 9 -14 -5 -2 -1 11	-358 -38 112 78 96 4 36 -110 0 253 -105 57 -35 -19 13 139 -91 53 -208 98 -8 94 -84 4 -252 162 78 350 -32 22 -131 -36 -121 16 -6 286 -275 100 -82 139 -54 121 -160 142 -247 305 -25 -27 -190 67 -138 129 -77 155 -342 102 -156 184 -24 238 -68 122 -572 297 -95 107 -243 127 -255 181 -193 441 -402 -48 62 286 -50 272 -6 -8 -388
10 -8 -3 12 -15 16 -6 13 -7 9 -14 -5 -2 -1 11 4	-36 110 0 114 -14 4 -208 98 -8 -139 91 -53 104 -110 66 -45 7 -49 252 -162 -78 -158 78 82 342 -102 156 -16 6 -286 -115 -42 165 305 -25 -27 160 -142 247 -21 88 -126 -30 -75 109 -129 77 -155 -61 -10 17 8 70 -134 68 -122 572 116 98 -334 -402 -48 62 -181 193 -441 -62 -66 186 105 143 -169 6 8 388 280 -58 -116 -358 -38 112
-8 -3 12 -15 16 -6 13 -7 9 -14 -5 -2 -1 11 4 -10	208 -98 8 -94 84 -4 252 -162 -78 45 -7 49 59 -103 17 -113 71 131 -342 102 -156 184 -24 238 -68 122 -572 -305 25 27 190 -67 138 -129 77 -155 30 75 -109 -51 13 -17 -31 65 -92 -8 -70 134 -53 60 -117 52 -116 286 402 48 -62 -286 50 -272 6 8 388 -105 -143 169 43 77 17 175 -201 53 358 38 -112 -78 -96 -4 -36 110 0
-3 12 -15 16 -6 13 -7 9 -14 -5 -2 -1 11 4 -10 8	-252 162 78 158 -78 -82 -342 102 -156 113 -71 -131 -54 -32 148 297 -95 107 68 -122 572 116 98 -334 -402 -48 62 129 -77 155 61 10 -17 -8 -70 134 31 -65 92 -82 78 -109 -22 -5 -25 -52 116 -286 -1 -56 169 97 73 -35 -6 -8 -388 -280 58 116 358 38 -112 -175 201 -53 218 -124 70 -253 105 -57 36 -110 0 -114 14 -4 208 -98 8
12 -15 16 -6 13 -7 9 -14 -5 -2 -1 11 4 -10 8 3	342 -102 156 -184 24 -238 68 -122 572 -297 95 -107 243 -127 255 -181 193 -441 402 48 -62 -286 50 -272 6 8 388 8 70 -134 53 -60 117 -52 116 -286 22 5 25 -104 73 -134 21 -51 194 -97 -73 35 96 17 134 123 -85 -233 -358 -38 112 78 96 4 36 -110 0 253 -105 57 -35 -19 13 139 -91 53 -208 98 -8 94 -84 4 -252 162 78
-15 16 -6 13 -7 9 -14 -5 -2 -1 11 4 -10 8 3 -12	-68 122 -572 -116 -98 334 402 48 -62 181 -193 441 62 66 -186 -105 -143 169 -6 -8 -388 -280 58 116 358 38 -112 52 -116 286 1 56 -169 -97 -73 35 -21 51 -194 -83 22 60 75 68 -60 -123 85 233 219 -68 -99 -350 32 -22 -36 110 0 114 -14 4 -208 98 -8 -139 91 -53 104 -110 66 -45 7 -49 252 -162 -78 -158 78 82 342 -102 156
1 14 -13 15 8 11 -5 -7 16 -3 -4 2 -9 6 -12 -10	-340 200 -136 156 -58 92 -156 92 -54 185 -13 -125 -25 -19 113 185 -47 -163 194 -156 172 -194 122 -210 -84 68 16 422 -310 234 -191 144 -115 120 -44 -54 -155 132 -80 16 -54 -36 -84 32 89 43 -141 187 28 41 -18 19 -65 93 -504 420 -332 226 -230 138 -84 -4 162 125 -251 285 -7 127 -41 -17 -17 -15 -280 438 -546 138 -204 246 46 62
14 -13 15 8 11 -5 -7 16 -3 -4 2 -9 6 -12 -10 -1	156 -92 54 0 34 38 194 -156 172 -185 47 163 160 -66 -50 -379 169 -47 84 -68 -16 -278 190 -194 504 -420 332 -120 44 54 -71 100 -169 43 -141 187 84 -32 -89 -68 -22 53 112 9 -107 -19 65 -93 47 -24 75 -82 110 -98 84 4 -162 142 -234 300 -280 438 -546 17 17 15 -24 110 -56 155 -187 261 -46 -62 202 184 -142 44 -340 200 -136
-13 15 8 11 -5 -7 16 -3 -4 2 -9 6 -12 -10 -1 -14	-194 156 -172 194 -122 210 84 -68 -16 379 -169 47 -219 103 -97 101 21 -147 -504 420 -332 226 -230 138 -84 -4 162 -43 141 -187 -28 -41 18 -19 65 -93 -112 -9 107 44 -13 -54 -65 -33 182 82 -110 98 -35 86 -23 -36 48 -108 280 -438 546 -138 204 -246 -46 -62 202 -155 187 -261 131 -77 205 29 45 -217 340 -200 136 -156 58 -92 156 -9
15 8 11 -5 -7 16 -3 -4 2 -9 6 -12 -10 -1 -14 13	-84 68 16 278 -190 194 -504 420 -332 -101 -21 147 -118 124 -244 125 -251 285 84 4 -162 142 -234 300 -280 438 -546 19 -65 93 -47 24 -75 82 -110 98 65 33 -182 -21 -46 128 30 119 -205 36 -48 108 -71 134 -131 237 -297 359 46 62 -202 -184 142 -44 340 -200 136 -29 -45 217 160 -32 -12 -185 13 125 -156 92 -54 0 -34 -38 -194 156 -1
8 11 -5 -7 16 -3 -4 2 -9 6 -12 -10 -1 -14 13 -15	504 -420 332 -226 230 -138 84 4 -162 -125 251 -285 7 -127 41 17 17 15 280 -438 546 -138 204 -246 -46 -62 202 -82 110 -98 35 -86 23 36 -48 108 -30 -119 205 9 73 -77 -101 15 74 -237 297 -359 166 -163 228 65 -3 -109 -340 200 -136 156 -58 92 -156 92 -54 185 -13 -125 -25 -19 113 185 -47 -163 194 -156 172 -194 122 -210 -84 68 16
11 -5 -7 16 -3 -4 2 -9 6 -12 -10 -1 -14 13 -15 -8	-84 -4 162 -142 234 -300 280 -438 546 -17 -17 -15 24 -110 56 -155 187 -261 46 62 -202 -184 142 -44 340 -200 136 -36 48 -108 71 -134 131 -237 297 -359 101 -15 -74 -92 88 -3 267 -178 154 -65 3 109 231 -166 119 -422 310 -234 156 -92 54 0 34 38 194 -156 172 -185 47 163 160 -66 -50 -379 169 -47 84 -68 -16 -278 190 -194 504 -420
-5 -7 16 -3 -4 2 -9 6 -12 -10 -1 -14 13 -15 -8 -11	-280 438 -546 138 -204 246 46 62 -202 155 -187 261 -131 77 -205 -29 -45 217 -340 200 -136 156 -58 92 -156 92 -54 237 -297 359 -166 163 -228 -65 3 109 -267 178 -154 175 -90 151 -36 12 -35 422 -310 234 -191 144 -115 120 -44 -54 -194 156 -172 194 -122 210 84 -68 -16 379 -169 47 -219 103 -97 101 21 -147 -504 420 -332 226 -230
-7 16 -3 -4 2 -9 6 -12 -10 -1 -14 13 -15 -8 -11 5	-46 -62 202 184 -142 44 -340 200 -136 29 45 -217 -160 32 12 185 -13 -125 156 -92 54 0 34 38 194 -156 172 65 -3 -109 -231 166 -119 422 -310 234 36 -12 35 139 -78 116 -155 132 -80 -120 44 54 -71 100 -169 43 -141 187 -84 68 16 278 -190 194 -504 420 -332 -101 -21 147 -118 124 -244 125 -251 285 84 4 -162 142 -234 300 -280 438 -

DRAFT-v1

1 -14 -13 -15 8 -11 -5 7 16 3 -4 -2 -9 -6 -12 10	60 -200 264 40 58 -24 28 -92 130 159 13 -151 -63 19 75 91 47 -257 -118 156 -140 50 -122 34 52 -68 152 -198 310 -386 97 -144 173 32 44 -142 109 -132 184 -92 54 -144 -20 -32 153 -239 141 -95 110 -41 64 -111 65 -37 336 -420 508 -234 230 -322 -92 4 154 -377 251 -217 247 -127 213 -51 17 -49 596 -438 330 -270 204 -162 170 -62 -7
-14 -13 -15 8 -11 -5 7 16 3 -4 -2 -9 -6 -12 10 -1	-28 92 -130 68 -34 106 -118 156 -140 -91 -47 257 28 66 -182 -41 -169 291 -52 68 -152 102 -190 186 -336 420 -508 -32 -44 142 129 -100 31 -239 141 -95 20 32 -153 -112 22 9 130 -9 -89 111 -65 37 -1 24 27 138 -110 122 92 -4 -154 -326 234 -168 596 -438 330 51 -17 49 196 -110 164 -219 187 -113 -170 62 78 -100 142 -240 60 -200 26
-13 -15 8 -11 -5 7 16 3 -4 -2 -9 -6 -12 10 -1 14	118 -156 140 -50 122 -34 -52 68 -152 41 169 -291 -13 -103 109 143 -21 -105 336 -420 508 -234 230 -322 -92 4 154 239 -141 95 -110 41 -64 111 -65 37 -130 9 89 18 13 -80 -131 33 116 -138 110 -122 137 -86 149 60 -48 -12 -596 438 -330 270 -204 162 -170 62 78 219 -187 113 -23 77 51 119 -45 -127 -60 200 -264 -40 -58 24 -28 92 -13
-15 8 -11 -5 7 16 3 -4 -2 -9 -6 -12 10 -1 14 13	52 -68 152 -102 190 -186 336 -420 508 -143 21 105 130 -124 4 -377 251 -217 92 -4 -154 -326 234 -168 596 -438 330 -111 65 -37 1 -24 -27 -138 110 -122 131 -33 -116 -113 46 36 268 -119 33 -60 48 12 197 -134 137 -357 297 -235 170 -62 -78 100 -142 240 -60 200 -264 -119 45 127 96 32 -76 -159 -13 151 28 -92 130 -68 34 -106 118 -1
8 -11 -5 7 16 3 -4 -2 -9 -6 -12 10 -1 14 13 15	-336 420 -508 234 -230 322 92 -4 -154 377 -251 217 -247 127 -213 51 -17 49 -596 438 -330 270 -204 162 -170 62 78 138 -110 122 -137 86 -149 -60 48 12 -268 119 -33 155 -73 69 -71 -15 104 357 -297 235 -160 163 -98 59 3 -115 60 -200 264 40 58 -24 28 -92 130 159 13 -151 -63 19 75 91 47 -257 -118 156 -140 50 -122 34 52 -68 152
-11 -5 7 16 3 -4 -2 -9 -6 -12 10 -1 14 13 15 -8	-92 4 154 326 -234 168 -596 438 -330 -51 17 -49 -196 110 -164 219 -187 113 170 -62 -78 100 -142 240 -60 200 -264 60 -48 -12 -197 134 -137 357 -297 235 71 15 -104 84 -88 173 -89 178 -202 -59 -3 115 -101 166 -213 198 -310 386 -28 92 -130 68 -34 106 -118 156 -140 -91 -47 257 28 66 -182 -41 -169 291 -52 68 -152 102 -190 186 -3
-5 7 16 3 -4 -2 -9 -6 -12 10 -1 14 13 15 -8 11	596 -438 330 -270 204 -162 170 -62 -78 -219 187 -113 23 -77 -51 -119 45 127 60 -200 264 40 58 -24 28 -92 130 -357 297 -235 160 -163 98 -59 -3 115 89 -178 202 -5 90 -29 -12 -12 -11 -198 310 -386 97 -144 173 32 44 -142 118 -156 140 -50 122 -34 -52 68 -152 41 169 -291 -13 -103 109 143 -21 -105 336 -420 508 -234 230 -322 -92 4
7 16 3 -4 -2 -9 -6 -12 10 -1 14 13 15 -8 11 5	-170 62 78 -100 142 -240 60 -200 264 119 -45 -127 -96 -32 76 159 13 -151 -28 92 -130 68 -34 106 -118 156 -140 59 3 -115 101 -166 213 -198 310 -386 12 12 11 -17 78 -40 109 -132 184 -32 -44 142 129 -100 31 -239 141 -95 52 -68 152 -102 190 -186 336 -420 508 -143 21 105 130 -124 4 -377 251 -217 92 -4 -154 -326 234 -168 596 -43
1 15 -5 -3 -9 -10 13 -11 -16 -2 12 14 8 -7 -4 6	388 70 -92 -250 14 -228 -60 82 292 -387 143 -113 240 -124 210 -77 47 -177 528 -154 74 -218 58 -138 188 -108 178 -233 39 -73 179 -56 213 38 -4 -320 303 -151 156 -163 78 -168 86 -91 263 -374 50 -34 157 10 141 -73 57 -321 78 -148 238 -108 98 -198 -16 -74 348 -219 159 -199 86 -32 126 -95 135 -349 220 54 -6 -96 -78 -144 -42 -6
15 -5 -3 -9 -10 13 -11 -16 -2 12 14 8 -7 -4 6 -1	60 -82 -292 -310 96 64 528 -154 74 77 -47 177 163 -77 33 -141 11 39 -188 108 -178 -30 -50 40 -78 148 -238 -38 4 320 217 -60 -107 -374 50 -34 -86 91 -263 -77 -13 95 71 101 -122 73 -57 321 84 67 -180 -155 -109 165 16 74 -348 -124 24 150 220 54 -6 95 -135 349 -9 103 -223 -1 -213 205 42 6 -464 -138 -84 320 388 70 -92
-5 -3 -9 -10 13 -11 -16 -2 12 14 8 -7 -4 6 -1 -15	-528 154 -74 218 -58 138 -188 108 -178 141 -11 -39 22 -66 72 111 -61 1 78 -148 238 -108 98 -198 -16 -74 348 374 -50 34 -157 -10 -141 73 -57 321 -71 -101 122 -6 88 -27 13 -34 -58 155 109 -165 -71 -42 -15 -22 78 -28 -220 -54 6 96 78 144 42 6 -464 1 213 -205 -10 -110 -18 -137 129 115 -388 -70 92 250 -14 228 60 -82 -292
-3 -9 -10 13 -11 -16 -2 12 14 8 -7 -4 6 -1 -15 5	188 -108 178 30 50 -40 78 -148 238 -111 61 -1 133 -127 73 -219 159 -199 16 74 -348 -124 24 150 220 54 -6 -73 57 -321 -84 -67 180 155 109 -165 -13 34 58 7 54 -85 -84 -8 43 22 -78 28 -93 36 -43 154 -104 40 -42 -6 464 138 84 -320 -388 -70 92 137 -129 -115 -147 19 97 387 -143 113 -60 82 292 310 -96 -64 -528 154 -74
-9 -10 13 -11 -16 -2 12 14 8 -7 -4 6 -1 -15 5 3	-78 148 -238 108 -98 198 16 74 -348 219 -159 199 -86 32 -126 95 -135 349 -220 -54 6 96 78 144 42 6 -464 -155 -109 165 71 42 15 22 -78 28 84 8 -43 -77 46 -42 -9 44 -86 -154 104 -40 61 -68 -3 -115 51 143 388 70 -92 -250 14 -228 -60 82 292 -387 143 -113 240 -124 210 -77 47 -177 528 -154 74 -218 58 -138 188 -108 178
-10 13 -11 -16 -2 12 14 8 -7 -4 6 -1 -15 5 3 9	-16 -74 348 124 -24 -150 -220 -54 6 -95 135 -349 9 -103 223 1 213 -205 -42 -6 464 138 84 -320 -388 -70 92 -22 78 -28 93 -36 43 -154 104 -40 9 -44 86 -86 90 -128 70 -112 83 115 -51 -143 -54 -17 140 233 -39 73 60 -82 -292 -310 96 64 528 -154 74 77 -47 177 163 -77 33 -141 11 39 -188 108 -178 -30 -50 40 -78 148 -238
13 -11 -16 -2 12 14 8 -7 -4 6 -1 -15 5 3 9 10	220 54 -6 -96 -78 -144 -42 -6 464 -1 -213 205 10 110 18 137 -129 -115 388 70 -92 -250 14 -228 -60 82 292 154 -104 40 -61 68 3 115 -51 -143 -70 112 -83 -16 -22 -45 -124 95 57 -233 39 -73 179 -56 213 38 -4 -320 -528 154 -74 218 -58 138 -188 108 -178 141 -11 -39 22 -66 72 111 -61 1 78 -148 238 -108 98 -198 -16 -74 348
-11 -16 -2 12 14 8 -7 -4 6 -1 -15 5 3 9 10 -13	42 6 -464 -138 -84 320 388 70 -92 -137 129 115 147 -19 -97 -387 143 -113 60 -82 -292 -310 96 64 528 -154 74 -115 51 143 54 17 -140 -233 39 -73 124 -95 -57 -140 73 12 303 -151 156 -38 4 320 217 -60 -107 -374 50 -34 188 -108 178 30 50 -40 78 -148 238 -111 61 -1 133 -127 73 -219 159 -199 16 74 -348 -124 24 150 220 54 -6

DRAFT-v1

1 -15 -5 3 -9 10 13 11 -16 2 12 -14 8 7 -4 -6	528 -70 48 -222 -14 -200 104 -82 456 -101 -143 173 -8 124 -38 17 -47 -83 220 154 -234 -102 -58 -22 -28 108 -38 -155 -39 5 67 56 101 30 4 -328 1 151 -146 -7 -78 -12 -96 91 81 -274 -50 66 177 -10 161 41 -57 -207 -218 148 -58 88 -98 -2 -164 74 200 99 -159 119 22 32 62 175 -135 -79 328 -54 102 -252 78 -300 -54 6 452
-15 -5 3 -9 10 13 11 -16 2 12 -14 8 7 -4 -6 -1	-104 82 -456 -118 -96 256 220 154 -234 -17 47 83 9 77 -121 -119 -11 61 28 -108 38 -130 50 -60 218 -148 58 -30 -4 328 97 60 -227 -274 -50 66 96 -91 -81 -103 13 69 273 -101 80 -41 57 207 218 -67 -46 -373 109 -53 164 -74 -200 -76 -24 198 328 -54 102 -175 135 79 197 -103 -17 -427 213 -221 54 -6 -452 -306 84 152 528 -70 48
-5 3 -9 10 13 11 -16 2 12 -14 8 7 -4 -6 -1 15	-220 -154 234 102 58 22 28 -108 38 119 11 -61 -110 66 -60 -11 61 -121 -218 148 -58 88 -98 -2 -164 74 200 274 50 -66 -177 10 -161 -41 57 207 -273 101 -80 170 -88 149 -55 34 -126 373 -109 53 -155 42 -99 134 -78 128 -328 54 -102 252 -78 300 54 -6 -452 427 -213 221 -230 110 -238 121 -129 373 -528 70 -48 222 14 200 -104 82 -456
3 -9 10 13 11 -16 2 12 -14 8 7 -4 -6 -1 15 5	-28 108 -38 130 -50 60 -218 148 -58 11 -61 121 -121 127 -181 99 -159 119 164 -74 -200 -76 -24 198 328 -54 102 41 -57 -207 -218 67 46 373 -109 53 55 -34 126 115 -54 23 -100 8 27 -134 78 -128 -21 -36 29 -54 104 -168 -54 6 452 306 -84 -152 -528 70 -48 -121 129 -373 -109 -19 135 101 143 -173 104 -82 456 118 96 -256 -220 -154 2
-9 10 13 11 -16 2 12 -14 8 7 -4 -6 -1 15 5 -3	218 -148 58 -88 98 2 164 -74 -200 -99 159 -119 -22 -32 -62 -175 135 79 -328 54 -102 252 -78 300 54 -6 -452 -373 109 -53 155 -42 99 -134 78 -128 100 -8 -27 15 -46 50 79 -44 2 54 -104 168 -75 68 -139 -13 -51 245 528 -70 48 -222 -14 -200 104 -82 456 -101 -143 173 -8 124 -38 17 -47 -83 220 154 -234 -102 -58 -22 -28 108 -38
10 13 11 -16 2 12 -14 8 7 -4 -6 -1 15 5 -3 9	-164 74 200 76 24 -198 -328 54 -102 175 -135 -79 -197 103 17 427 -213 221 -54 6 452 306 -84 -152 -528 70 -48 134 -78 128 21 36 -29 54 -104 168 -79 44 -2 94 -90 52 -154 112 -141 13 51 -245 -88 17 106 155 39 -5 -104 82 -456 -118 -96 256 220 154 -234 -17 47 83 9 77 -121 -119 -11 61 28 -108 38 -130 50 -60 218 -148 58
13 11 -16 2 12 -14 8 7 -4 -6 -1 15 5 -3 9 -10	328 -54 102 -252 78 -300 -54 6 452 -427 213 -221 230 -110 238 -121 129 -373 528 -70 48 -222 -14 -200 104 -82 456 -54 104 -168 75 -68 139 13 51 -245 154 -112 141 -60 22 -89 66 -95 247 -155 -39 5 67 56 101 30 4 -328 -220 -154 234 102 58 22 28 -108 38 119 11 -61 -110 66 -60 -11 61 -121 -218 148 -58 88 -98 -2 -164 74 200
11 -16 2 12 -14 8 7 -4 -6 -1 15 5 -3 9 -10 -13	54 -6 -452 -306 84 152 528 -70 48 121 -129 373 109 19 -135 -101 -143 173 -104 82 -456 -118 -96 256 220 154 -234 -13 -51 245 88 -17 -106 -155 -39 5 -66 95 -247 6 -73 158 1 151 -146 -30 -4 328 97 60 -227 -274 -50 66 -28 108 -38 130 -50 60 -218 148 -58 11 -61 121 -121 127 -181 99 -159 119 164 -74 -200 -76 -24 198 328 -54 102

References

- [1] E. Feig and S. Winograd, "Fast algorithms for the discrete cosine transform" IEEE Transactions on Signal Processing, vol. 40, no. 9, pp. 2174–2193, 1992
- [2] C. Loeffler, A. Ligtenberg, and G.S. Moschytz, "Practical fast 1-D DCT algorithms with 11 multiplications" in Proc. IEEE Int. Conf. Acoust., Speech, and Sig. Proc. (ICASSP'89), vol. 2, pp. 988-991, February 1989.
- [3] "ITU-T Rec. H.265 and ISO/IEC 23008-2: High efficiency video coding," ITU-T and ISO/IEC, 2013.

