

BerryClip

6 LED Buzzer Board

The quick and easy way to
experiment with the Raspberry Pi

Introduction

The BerryClip is a simple, cheap and easy to use add-on board for the Raspberry Pi. It plugs directly onto the Pi's GPIO header and provides 6 coloured LEDs, 1 Buzzer and 1 Switch. It can be controlled using any programming language that can manipulate the GPIO pins and this includes Python and C.

Parts

The kit of parts includes :

- 1 Circuit board
- 2 Red LEDs
- 2 Yellow LEDs
- 2 Green LEDs
- 6 330 ohm resistors
- 1 1Kohm resistor
- 1 10Kohm resistor
- 1 Buzzer
- 1 Switch
- 1 26 way header connector
- 1 Rubber bumper

Resistor Colour Codes

The value of a resistor is indicated by bands of colour. The resistors on the BerryClip will have the following colour codes :

- 330 ohm **Orange-Orange-Brown**
- 1K ohm **Brown-Black-Red**
- 10K ohm **Brown-Black-Orange**

The PCB

The PCB is labelled to identify where each component should be placed.

P1	26-way header
Buzz1	5v buzzer
S1	Micro-switch
R1-R6	330 ohm (Orange-Orange-Brown)
R7	1K ohm (Brown-Black-Red)
R8	10K ohm (Brown-Black-Orange)
LED1,2	Red LEDs
LED3,4	Yellow LEDs
LED5,6	Green LEDs

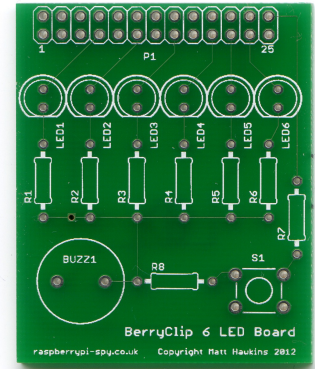

- i** Take care to ensure the 1K and 10K resistors are placed in the correct positions.
- i** Take a look at the photos to ensure you solder the 26 way header onto the correct side of the board.
- i** The LEDs have a short leg (Cathode) and long leg (anode). Make sure the long leg is inserted into the hole nearest the P1 Header. The short leg should be inserted into the hole nearest the resistor.

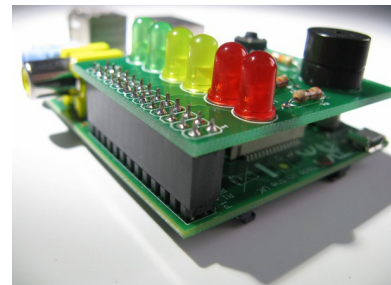
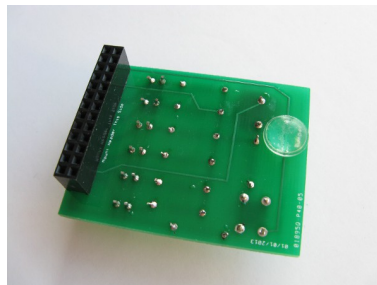
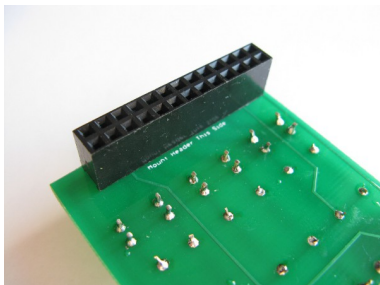
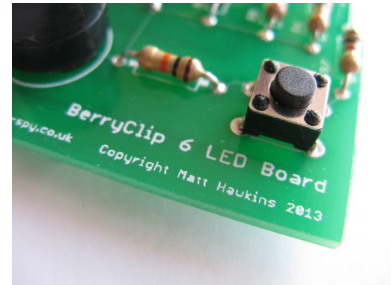
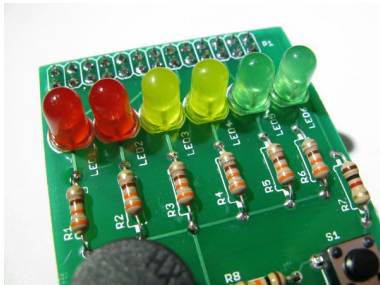

Assembly & Soldering

If you have never soldered before or you need a quick refresher then I can recommend the "Soldering Is Easy" comic :

http://mightyohm.com/files/soldercomic/FullSolderComic_EN.pdf

or this SparkFun page :

<http://www.sparkfun.com/tutorials/106>

Recommended Soldering Sequence :

- Solder 26-way header
- Solder 8 resistors
- Solder 6 LEDs
- Solder 1 switch
- Solder 1 buzzer

When soldering the header make sure you don't use too much solder or you may short-circuit the pins underneath the PCB.

Once the components are soldered :

- Visually check your solder joints and ensure there are no stray blobs or splashes of solder that might short-circuit any pins.
- Remove the label on the buzzer.
- Stick rubber bumper to underside of board so it will rest on large silver capacitor (C6) on the Raspberry Pi.
- If possible use a multimeter to check there are no short-circuits between adjacent header pins.

Plug the board onto your Raspberry Pi. Stand back and admire your work.

Software Setup

To start with you will need a working SD card. I would recommend starting with a fresh copy of Raspbian. This image can be downloaded from from raspberrypi.org/downloads

Once you've got an SD card prepared put it in your Pi, power it up and login with default user name and password ('pi' and 'raspberry')

You will now be located in the 'pi' user home directory ('/home/pi/').



Type the following commands pressing the Enter key at the end of each line :

```
mkdir berryclip
cd berryclip
wget https://bitbucket.org/MattHawkinsUK/rpisp-y-berryclip/get/master.tar.gz
tar -xvf master.tar.gz --strip 1
```

The above lines perform the following functions :

- Makes a new directory called 'berryclip'
- Navigates into that directory
- Grabs an archive of all the files from the BitBucket.org website
- Extracts the files to your Pi

The script will download an instruction file and a set of example Python scripts.

To list the downloaded files type :

```
ls -l
```

You can use the following command to remove the gz archive as we don't need that now we have extracted the files :

```
rm master.tar.gz
```

Run Some Example Python Scripts

The following example Python scripts are available :

- `berryclip_01.py` – Test LEDs only
- `berryclip_02.py` – Test Buzzer only
- `berryclip_03.py` – Test Switch only
- `berryclip_04.py` – Test LEDs and Switch
- `berryclip_05.py` – Test LEDs, Buzzer and Switch
- `berryclip_06.py` – LED sequence
- `berryclip_07.py` – Dice Simulator
- `berryclip_08.py` – Reaction time game
- `berryclip_09.py` – Random LEDs
- `berryclip_10.py` – Multiple LED sequences in a loop
- `berryclip_11.py` – Traffic light simulator
- `berryclip_12.py` – Morse code generator



To run a script you can use the following command :

```
sudo python berryclip_01.py
```

To quit a running Python script use [CTRL-C].

To view a text file or Python script you can use the command :

```
cat berryclip_01.py
```

Modifying Scripts

Once you have tested your BerryClip and tried the example scripts you can start to develop your own examples. You can use any text editor you prefer to edit the scripts but here are some quick tips.

Copy an existing scripts to a new file by using :

```
cp berryclip_01.py myfile.py
```

Edit a script in the nano text editor using :

```
nano myfile.py
```

Make your changes and save using CTRL+O .You can quit nano by pressing CTRL+X.

Adjusting the time.sleep() statements is a good thing to start with. Or maybe adding additional print statements.

Additional Information

The following information is provided for those that are simply curious or are looking to modify their BerryClip.

Hardware Reference

Here is a list of components, the header pins they connect to and the GPIO reference you can use you control them :

LED 1	Pin 07	GPIO4
LED 2	Pin 11	GPIO17
LED 3	Pin 15	GPIO22
LED 4	Pin 19	GPIO10
LED 5	Pin 21	GPIO9
LED 6	Pin 23	GPIO11
Buzzer	Pin 24	GPIO8
Switch	Pin 26	GPIO7

LED Currents

The LED current limiting resistors are 330Ω. The voltage provided by the GPIO pins is 3.3V. The LEDs drop approximately 2-2.2V. This leaves the resistor dropping 1.1-1.3V. The resistors have a tolerance of 5% so could vary in value between 310Ω and 350Ω.

So using Ohm's Law :

$$V = IR \qquad I = \frac{V}{R}$$

we can calculate that the LEDs each draw between 3.1mA and 4.2mA.

Circuit Diagram

Here is a circuit diagram showing how the LEDs, switch and buzzer are connected to the GPIO header via the resistors.

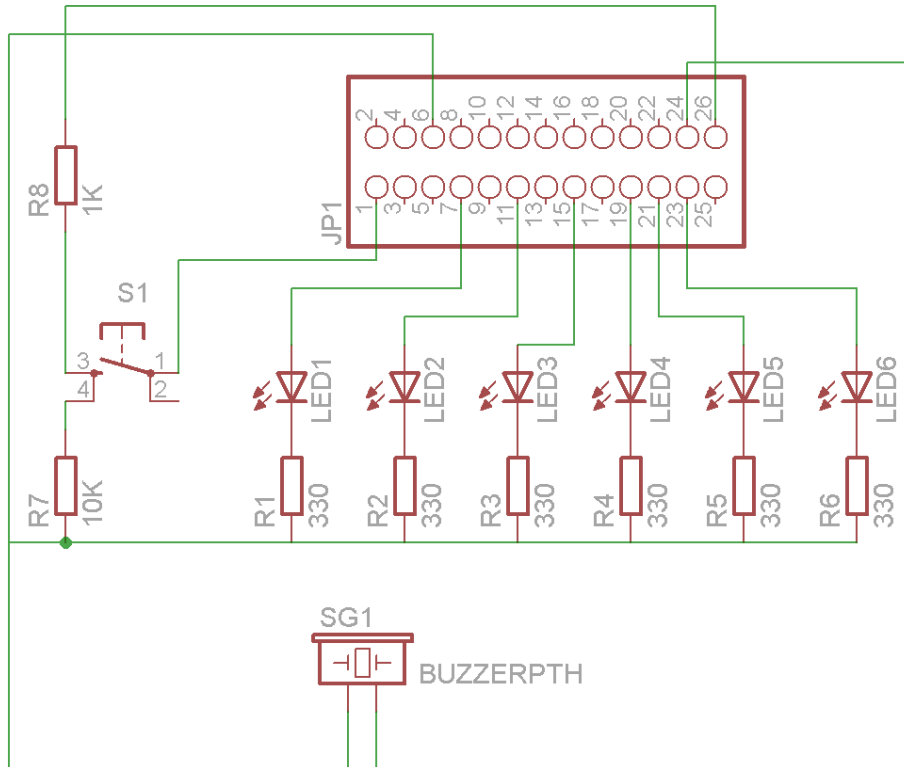

BerryClip – 6 LED Buzzer Board

19 December 2013

Raspberry Pi is a trademark of the Raspberry Pi Foundation

<http://www.raspberrypi-spy.co.uk/>